

WALCHEM

An Iwaki America Company

WebMaster®ONE Controllers

*Web*Master[®]**ONE**
Water Treatment Controller
Instruction Manual

Five Boynton Road Hopping Brook Park Holliston, MA 01746 USA

TEL: 508-429-1110 FAX: 508-429-7433 WEB: www.walchem.com

Notice

© 2012 WALCHEM, An Iwaki America Incorporated Company (hereinafter "Walchem")
Five Boynton Road, Holliston, MA 01746 USA
(508) 429-1110
All Rights Reserved
Printed in USA

Proprietary Material

The information and descriptions contained herein are the property of WALCHEM. Such information and descriptions may not be copied or reproduced by any means, or disseminated or distributed without the express prior written permission of WALCHEM, Five Boynton Road, Holliston, MA 01746.

Statement of Limited Warranty

WALCHEM warrants equipment of its manufacture, and bearing its identification to be free from defects in workmanship and material for a period of 24 months for electronics and 12 months for mechanical parts and electrodes from date of delivery from the factory or authorized distributor under normal use and service and otherwise when such equipment is used in accordance with instructions furnished by WALCHEM and for the purposes disclosed in writing at the time of purchase, if any. WALCHEM's liability under this warranty shall be limited to replacement or repair, F.O.B. Holliston, MA U.S.A. of any defective equipment or part which, having been returned to WALCHEM, transportation charges prepaid, has been inspected and determined by WALCHEM to be defective. Replacement elastomeric parts and glass components are expendable and are not covered by any warranty.

THIS WARRANTY IS IN LIEU OF ANY OTHER WARRANTY, EITHER EXPRESS OR IMPLIED, AS TO DESCRIPTION, QUALITY, MERCHANTABILITY, and FITNESS FOR ANY PARTICULAR PURPOSE OR USE, OR ANY OTHER MATTER.

180272 Rev X
April 2012

TABLE OF CONTENTS

1.0	INTRODUCTION	1
2.0	SPECIFICATIONS	1
2.1	MEASUREMENT PERFORMANCE	1
2.2	ELECTRICAL	2
2.3	MECHANICAL	3
2.4	VARIABLES AND THEIR LIMITS	5
3.0	UNPACKING & INSTALLATION.....	10
3.1	UNPACKING THE UNIT.....	10
3.2	MOUNTING THE ELECTRONIC ENCLOSURE.....	10
3.3	INSTALLATION.....	10
3.4	ICON DEFINITIONS.....	14
3.5	ELECTRICAL INSTALLATION.....	18
4.0	FUNCTION OVERVIEW	27
4.1	FRONT PANEL.....	27
4.2	DISPLAY.....	27
4.3	KEYPAD.....	28
4.4	ACCESS CODES.....	28
4.5	INITIAL STARTUP.....	28
4.6	COMMUNICATING WITH THE WEBMASTERONE.....	30
4.7	STARTUP.....	36
4.8	SHUT DOWN.....	36
5.0	OPERATION – USING LOCAL DISPLAY AND KEYPAD.....	36
5.1	INPUT SUMMARY.....	36
5.2	INDICES.....	37
5.3	OUTPUT SUMMARY.....	37
5.4	ALARMS.....	37
5.5	CALIBRATION.....	37
5.7	SET POINTS.....	44
5.8	COMMUNICATION.....	48
5.9	ACCESS CODES.....	50
5.10	SOFTWARE UPGRADE.....	50
5.11	COPY TO USB DISK.....	50
5.12	FEATURE ACTIVATIONS.....	51
5.13	CONTROLLER RESTART.....	51
6.0	OPERATION – USING PC	51
6.1	MENU SELECTION LINKS.....	52
6.2	START UP MENU.....	52
6.3	SYSTEM SUMMARY MENU.....	57
6.4	SENSOR MENU - CONDUCTIVITY INPUT.....	58
6.5	SENSOR MENU - pH INPUT.....	61
6.6	SENSOR MENU - ORP INPUT.....	65
6.7	SENSOR MENU – CHLORINE, CHLORINE DIOXIDE INPUTS.....	68
6.8	LEVEL (4-20 mA) INPUT MENU.....	72
6.9	FLOW METER (4-20 mA) INPUT MENU.....	74
6.10	GENERIC (4-20 mA) INPUT MENU.....	75
6.11	4-20 mA INPUT MENU.....	77
6.12	FLOW METER (DIGITAL) INPUT MENU.....	79
6.13	INTERLOCK MENU.....	81

6.14 ... FEED VERIFICATION INPUT MENU.....	81
6.15 ... LEVEL SWITCHES (DIGITAL) INPUT MENU	82
6.16 ... GENERIC (DIGITAL) INPUTS MENU.....	82
6.17 ... COUNTER INPUTS MENU	83
6.18 ... DIGITAL INPUTS MENU.....	84
6.19 ... RELAY (1 – 8) OUTPUT MENUS – ON/OFF SET POINT TYPES	84
6.20 ... RELAY (1-8) OUTPUT MENU – TIME PROPORTIONAL TYPES	87
6.21 ... RELAY (1 – 8) OUTPUT MENUS – CYCLES OF CONCENTRATION TYPES.....	89
6.22 ... RELAY (1 – 8) OUTPUT MENUS – INTERMITTENT (FIXED BLOWDOWN TIME) TYPES	92
6.23 ... RELAY (1 – 8) OUTPUT MENUS – INTERMITTENT (PROPORTIONAL BLOWDOWN TIME) TYPES.....	94
6.24 ... RELAY (1 - 8) OUTPUT MENU – FLOW BASED FEED TYPE.....	97
6.25 ... RELAY (1-8) OUTPUT MENU – FEED WITH ANOTHER RELAY TYPES	99
6.26 ... RELAY (1 – 8) OUTPUT MENU – FEED AFTER ANOTHER RELAY (%) TYPES.....	101
6.27 ... RELAY (1-8) OUTPUT MENU – FEED AFTER ANOTHER RELAY (FIXED TIME)	103
6.28 ... RELAY (1 – 8) OUTPUT MENU – FEED AS % OF TIME TYPES.....	105
6.29 ... RELAY (1 – 8) OUTPUT MENU – BIOCIDES TIMER BASED TYPES	107
6.30 ... RELAY (1 – 8) OUTPUT MENU – SPIKE SET POINT TYPES	110
6.31 ... RELAY (1 – 8) OUTPUT MENU – DISPERSANT TYPES	113
6.32 ... RELAY (1-8) OUTPUT MENU - BLEED VOLUME BASED ON MAKEUP VOLUME	115
6.33 ... RELAY (1- 8) OUTPUT MENU – ALARM TYPE.....	117
6.34 ... RELAY (1-8) OUTPUT MENU – ACTIVATE ON A DI	119
6.35 ... RELAY (1 - 8) OUTPUT MENU – TARGET PPM FEED TYPE	121
6.36 ... RELAY (1 - 8) OUTPUT MENU – TARGET PPM FEED WITH FEED VERIFICATION TYPE	124
6.37 ... ANALOG OUTPUT (1-4) MENU – RETRANSMIT MODE	127
6.38 ... ANALOG OUTPUT MENUS (1-4) - PROPORTIONAL FEED MODE	128
6.39 ... REMOTE ALARMING	131
6.40 ... LSI/RSI.....	132
6.41 ... VTOUCH CONFIG	133
6.42 ... SYSTEM STATUS AUTO-REPORTING	134
6.43 ... DATALOG AUTO REPORT	135
6.44 ... MANUAL DATALOG.....	137
6.45 ... GRAPHING/TRENDING	140
6.46 ... COMMUNICATIONS MENU	140
6.47 ... ADVANCED COMMS	145
6.48 ... CONFIGURATION FILE MENU.....	146
6.49 ... NOTEPAD	147
6.50 ... ACCESS CODES.....	147
6.51 ... SOFTWARE UPGRADES (ONLY APPEARS IF A NEWER REVISION OF SOFTWARE IS AVAILABLE)	147
6.52 ... SUB-NETWORK	148
7.0 MAINTENANCE.....	149
7.1 FLOW SWITCH CLEANING	149
7.2 CONDUCTIVITY SENSOR CLEANING AND CALIBRATION	151
7.3 pH ELECTRODE CLEANING AND CALIBRATION	152
7.4 ORP ELECTRODE CLEANING AND CALIBRATION	152
7.5 DISINFECTION SENSOR CLEANING AND CALIBRATION	153
7.6 REPLACING THE FUSES.....	153
8.0 TROUBLESHOOTING	154
8.1 ERROR MESSAGES	154
8.2 PROBLEMS THAT DON'T GENERATE AN ERROR MESSAGE.....	171
8.3 CONNECTION PROBLEMS	173
9.0 SERVICE POLICY	174

1.0 INTRODUCTION

The WebMasterONE series controller is multi-functional, but not all of the features mentioned are necessarily present in the controller you have received. All features can be added in the field. The controller may be configured to control a cooling tower, or a boiler, or both.

Standard features include a direct sensor measurement of either conductivity, pH, or ORP; six digital inputs (for flow switch, metering pump flow feedback, counter, or other use), eight relay outputs, and both Ethernet and USB connections to a computer.

Optional features include:

Up to three additional pH, ORP, chlorine, chlorine dioxide and/or conductivity measurements.

Up to six digital inputs (for level switch, metering pump flow feedback, counter, or other use).

Up to eight 4-20 mA inputs (for drum level, flow meters, or practically any other parameter).

Up to four 4-20 mA outputs (for retransmission of the conductivity, pH, ORP, Cl₂, ClO₂, temperature or any 4-20 mA input signals).

A modem card (for remote communications)

The controller can log data and events, automatically generate reports on a periodic basis at a programmable frequency, and if equipped with a modem card, dial out in the event of an alarm condition. The alarm notification may be via phone to a pager, or email.

Our revolutionary digital communications package allows you to change set points, manually activate or deactivate pumps and valves, upgrade software, receive reports and alarms, *from any PC that has Internet access. No proprietary software needs to be installed on the PC, only a web browser.*

2.0 SPECIFICATIONS

2.1 Measurement Performance

Contacting Conductivity

Range 0-10,000 μ S/cm
Resolution 1 μ S/cm
Calibration \pm 50% of raw reading;
scalable to read in ppm

pH

Range -2 to 16 pH units
Resolution 0.01 pH units
Calibration single or dual point

mV

Range \pm 1400 mV
Resolution 1 mV
Calibration single or dual point

Temperature

Range 32 to 392 °F (0 to 200 °C)
Resolution 1 °F (1 °C)
Calibration single point; degrees C or F

Chlorine

Range 0 to 8 mg/l
Resolution 0.01 mg/l
Calibration single or dual point

Chlorine Dioxide

Range 0 to 10 mg/l
Resolution 0.01 mg/l
Calibration single or dual point

Electrodeless Conductivity

Ranges 50 to 1000 μ S/cm, 1-10 mS/cm, 10-100 mS/cm, or 100-1000 mS/cm
Resolution 1 μ S/cm or 1 mS/cm (range dependent)
Calibration single or dual point; scalable to read in ppm or % concentration

2.2 Electrical

Inputs

Input power	100 – 120/220-240 VAC ±10%, 12A, 50/60 Hz	Fuse	1.6A, 5 x 20mm
Input signals			
State-Type Digital Inputs	Electrical: Non-isolated 5 VDC with 301K ohm pull-up Typical response time: <10 seconds Devices supported: Any isolated dry contact (i.e. relay, reed switch) Types: Interlock, Level switch, Generic input		
Low Speed Counter-Type Digital Inputs	Electrical: Non-isolated 5 VDC with 301K ohm pull-up, 0-10 Hz, 50 msec minimum width Devices supported: Any device with isolated open drain, open collector, transistor or reed switch Supported on inputs: Standard inputs A-D, Optional inputs 1-6 Types: Contacting Flowmeter, Feed Verification, Generic Counter		
High Speed Counter-Type Digital Inputs	Electrical: Non-isolated 5 VDC with 301K ohm pull-up, 0-400 Hz, 1.25 msec minimum width Devices supported: Any device with isolated open drain, open collector, transistor or reed switch Supported on inputs: Standard inputs A-D, Optional inputs 5-6 Types: Paddlewheel Flowmeter, Generic Counter		
Analog Inputs (1-8) (Optional)	4-20 mA, 2-wire or 3 -wire, internally powered by 24 VDC, 25 ohm input resistance, 1000 ohm maximum load. Typical response time <10 seconds		
Sensor <u>STANDARD (1)</u>		Sensor <u>OPTIONAL (3)</u>	
Signal (isolated)	±1.5V	Signal (isolated)	±1.5V
Temp (isolated)	1K or 10K or 100K ohm	Temp (isolated)	1K or 10K or 100K ohm

Outputs

STANDARD

Mechanical relays: At 115 VAC, 10 amp (resistive), 1/8 HP
At 230 VAC, 6 amp (resistive), 1/8 HP

R1, R2, R3, and R4 relays are fused together as one group, total current for this group must not exceed 5.5A
R5, R6, R7 and R8 relays are fused together as one group, total current for this group must not exceed 5.5A.
Relays 1-8 may be dry contact or may switch line (mains) voltage, depending upon model code; refer to Figure 4. Powered relays have both NO and NC terminals available. Only powered relays are fused.

Digital: USB
Ethernet, 10 Base T

OPTIONAL

4-20 mA (1-4): Isolated, 500 ohm max. resistive load, internally powered

Agency Approvals

UL	ANSI/UL 61010-1:2004, 2 nd Edition *
CAN/CSA	C22,2 No.61010-1:2004, 2 nd Edition *
CE Safety	EN 61010-1 2 nd Edition (2001) *
CE EMC	EN 61326 :1998 Annex A *

Note: For EN61000-4-3,-6 the controller met performance criteria B.

* Equipment suitable for use in establishments other than domestic, and those directly connected to a low voltage (100-240 VAC) power supply network which supplies buildings used for domestic purposes.

2.3 Mechanical

Enclosure

Material:	Polycarbonate
NEMA Rating:	NEMA 4X
Dimensions:	10" x 12" x 5-5/8" (25.4cm x 30.5cm x 14.5cm)
Display:	64 x 128 Pixel Backlit LCD Graphics Module
Operating Ambient Temp:	0 to 49° C (32-120°F)
Storage Temp:	-29 to 80°C
Weight	11.5lb (5.2kg)

Flow switch manifold

Pressure:	150 psi up to 100° F, 50 psi @140° F
Temperature:	0 to 140°F
Process connections:	3/4" NPTF
Wetted Materials of construction:	Glass-Filled Polypropylene, PVC, FKM, Isoplast

pH Electrode

Pressure:	0 to100 psi
Temperature:	50 to158°F
Process connections:	3/4" NPTF
Wetted Materials of Construction:	Glass-Filled Polypropylene, CPVC, HDPE, FKM, Glass

ORP electrode

Pressure:	0 to100 psi
Temperature:	32 to 158°F
Process connections:	3/4" NPTF
Wetted Materials of Construction:	Glass-Filled Polypropylene, CPVC, HDPE, FKM, Platinum, Glass

Contacting conductivity electrode

Pressure:	0 to150 psi
Temperature:	32 to158°F
Process connections:	3/4" NPTF
Wetted Materials of Construction:	Glass-Filled Polypropylene, Graphite, FKM

Electrodeless conductivity sensor

Pressure:	0 to150 psi
Temperature:	32 to158°F
Process connections:	3/4" NPTF
Wetted Materials of Construction:	Glass-Filled Polypropylene, CPVC, FKM

Stainless steel contacting conductivity electrode

Pressure:	0-150 psi
Temperature:	32-158F
Process connections:	3/4" NPTF
Wetted Materials of Construction:	Glass-Filled Polypropylene, 316 SS, FKM

Chlorine, Chlorine Dioxide sensors

Pressure:	0 to 1 atm (0 to 14.7 psi)
Temperature	
Chlorine Dioxide sensors:	0 to 50 °C (32 to 122 °F)
Chlorine:	0 to 45°C (32 to 113°F)
Flow Cell Inlet:	¼” NPTF
Flow Cell Outlet:	¾” NPTF
Wetted Materials of Construction:	PVC, Silicone or PTFE, Nylon, Isoplast, FKM

High pressure tower contacting conductivity electrode

Pressure:	0-300 psi
Temperature:	32-158F
Process connections:	¾” NPTM
Wetted Materials of Construction:	316 SS, PEEK

High pressure boiler contacting conductivity electrode

Pressure:	0-250 psi
Temperature:	32-392F
Process connections:	¾” NPTM
Wetted Materials of Construction:	316 SS, PEEK

High pressure pH electrode

Pressure:	0-300 psi
Temperature:	32-275F
Process connections:	¾” NPTM
Wetted Materials of Construction:	Glass, Polymer, PTFE, 316 SS, FKM

High Pressure ORP electrode

Pressure:	0-300 psi
Temperature:	32-275F
Process connections:	¾” NPTM
Wetted Materials of Construction:	Platinum, Polymer, PTFE, 316 SS, FKM

High Pressure flow switch

Pressure:	0-300 psi
Temperature:	32-158F
Process connections:	¾” NPTF
Wetted Materials of Construction:	Carbon steel, Brass, 316SS, FKM”

2.4 Variables and their Limits

All menus shown may not be available. The menus that appear on your controller will vary with options installed and programmed.

Sensor Input Menu – if pH

Calibration Reminder	0-365 days
Alarm Limits	-2 to 16
Alarm Dead Band	-2 to 16
Deviation from Primary Sensor	0.01 to 18
Damping	0 to 60 seconds
Temperature Alarm Limits	0 to 70 °C (0 to 158°F)

Sensor Input Menu – if ORP

Calibration Reminder	0-365 days
Alarm Limits	-1400 to 1400 mV
Alarm Dead Band	-1400 to 1400 mV
Deviation from Primary Sensor	0.01 to 2800 mV
Damping	0 to 60 seconds
Temperature Alarm Limits	0 to 70 °C (0 to 158°F)

Sensor Input Menu – if Contacting Conductivity

Calibration Reminder	0 – 365 days
ppm Conversion Factor	0.5 – 1.0
Alarm Limits	0 to 10,000 (units defined by user)
Alarm Dead Band	0 to 30,000 (units defined by user)
Deviation from Primary Sensor	0.01 to 30,000 (units defined by user)
Damping	0 to 60 seconds
Temperature Alarm Limits	0 to 70 °C (0 to 158°F)

Sensor Input Menu – if High Temp Contacting Conductivity

Calibration Reminder	0 – 365 days
ppm Conversion Factor	0.5 – 1.0
Alarm Limits	0 to 10,000 (units defined by user)
Alarm Dead Band	0 to 30,000 (units defined by user)
Deviation from Primary Sensor	0.01 to 30,000 (units defined by user)
Damping	0 to 60 seconds
Temperature Alarm Limits	0 to 200 °C (32 – 392 °F)

Sensor Input Menu – if Electrodeless Conductivity

Calibration Reminder	0 – 365 days
ppm Conversion Factor	0.5 – 1.0
Alarm Limits	0 to full scale of range
Alarm Dead Band	0 to full scale of range
Deviation from Primary Sensor	0.01 to full scale of range
Temperature Alarm Limits	0 to 88 °C (0 to 190°F)

Sensor Input Menu – if Chlorine or Chlorine Dioxide

Calibration Reminder	0-365 days
Alarm Limits	0 to 10 mg/l
Alarm Dead Band	0 to 10 mg/l
Deviation from Primary Sensor	0.01 to 10 mg/l
Damping	0 to 60 seconds
Temperature Alarm Limits	0 to 70 °C (0 to 158°F)

Flowmeter Input Menu – Analog Input Type

Flow Rate at 4 mA	0 to 1000 (units of measure defined by user)
Flow Rate at 20 mA	0 to 1000 (units of measure defined by user)

Level Input Menu – Analog Input Type

Empty mA	0 to 20 mA
Full mA	0 to 20 mA
Full volume	0 to 10,000 (units defined by user)
Low Level Alarm Limit	0.001 to 10,000 (units defined by user)

Generic 4-20 mA Input Menu

Parameter = 4 mA	-10,000 to 10,000 (units defined by user)
Parameter = 20 mA	-10,000 to 10,000 (units defined by user)
Low Alarm Limit	-100,000,000 to 100,000,000 (units defined by user)
High Alarm Limit	-100,000,000 to 100,000,000 (units defined by user)

Flowmeter Input Menu – Digital Input Type

Volume per Contact	0 to 1000 (units of measure defined by user)
K Factor	0.001 to 20,000 (Pulses per Gallon or Liter)
Total Alarm Limit	0 = no limit, otherwise >0
Rate High Alarm	>0
Rate Low Alarm	>0

Feed Verification Input Menu

Alarm Time	0.1 to 10 minutes
Pump Volume per Stroke	0.000 to 100 (units of measure defined by user)

Counter Input Menu

One Count =	>0
Total Alarm Limit	0 =no limit, otherwise >0
Rate High Alarm	>0
Rate Low Alarm	>0

Relay Output Menu – On/Off Set Point

Set Point	Full scale range of the input parameter
Dead Band	Full scale range of the input parameter
Output Time Limit	0 = ∞, 1 to 1440 minutes
Hand Time Limit	0 = ∞, 1 to 1440 minutes

Relay Output Menu – Time Proportional

Set Point	Full scale range of the input parameter
Sample Period	1 to 1440 minutes
Proportional Band	Full scale range of the input parameter
Output Time Limit	0 = ∞, 1 to 1440 minutes
Hand Time Limit	0 = ∞, 1 to 1440 minutes

Relay Output Menu – Feed with Another Relay

Output Time Limit	0 = ∞, 1 to 1440 minutes
Hand Time Limit	0 = ∞, 1 to 1440 minutes

Relay Output Menu – Feed after Another Relay (Fixed Time)

Fixed Time to Feed	0 to 1440 minutes
Hand Time Limit	0 = ∞, 1 to 1440 minutes

Relay Output Menu – Flow Based Feed

Volume to trigger Feed	1 to 99,999 (units defined by user)
Feed Time per unit Volume	1 second to 1440 minutes
Output Time Limit	0 = ∞, 1 to 1440 minutes
Hand Time Limit	0 = ∞, 1 to 1440 minutes

Relay Output Menu – Biocide Timer Based

Output On-Time	1 to 1440 min
Hand Time Limit	0 = ∞, 1 to 1440 minutes

Relay Output Menu – Feed After Another Relay (%)

% of Relay to Feed	0 to 100%
Output Time Limit	0 = ∞, 1 to 1440 minutes
Hand Time Limit	0 = ∞, 1 to 1440 minutes

Relay Output Menu – Feed as % Time

Time Period	1 – 1440 minutes
% of Period to Feed	0.1 to 100%
Output Time Limit	0 = ∞, 1 to 1440 minutes
Hand Time Limit	0 = ∞, 1 to 1440 minutes

Relay Output Menu – Cycles of Concentration

Cycles Set Point	1 – 50 cycles
Cycles Dead band	0.01 – 20 cycles
Cycles Low Alarm	0 – 50 cycles
Cycles High Alarm	0 – 50 cycles
Output Time Limit	0 = ∞, 1 to 1440 minutes
Hand Time Limit	0 = ∞, 1 to 1440 minutes

Relay Output Menu – Spike

Set Point	Full scale range of the parameter
Dead Band	Full scale range of the parameter
Relay On-Time	1 sec to 1440 minutes
Hand Time Limit	0 = ∞, 1 to 1440 minutes

Relay Output Menu – Intermittent, Fixed Blowdown Time

Set Point	Full scale range of the parameter
Interval Time	5 to 1440 minutes
Duration of Sample	10 seconds to 60 minutes
Hold Time	30 seconds to 10 minutes
Blowdown Time	1 to 1440 minutes
Hand Time Limit	0 = ∞, 1 to 1440 minutes

Relay Output Menu – Intermittent, Proportional Blowdown Time

Set Point	Full scale range of the parameter
Interval Time	5 to 1440 minutes
Duration of Sample	10 seconds to 60 minutes
Hold Time	30 seconds to 10 minutes
Blowdown Time	1 to 1440 minutes
Hand Time Limit	0 = ∞, 1 to 1440 minutes

Relay Output Menu - Alarm

On Delay Time	0 to 1440 minutes
Power Up On Delay Time	0 to 1440 minutes
Output Time Limit	0 = ∞, 1 to 1440 minutes
Hand Time Limit	0 = ∞, 1 to 1440 minutes

Relay Output Menu – Activate on a DI

On Delay Time	10 seconds to 1440 minutes
Off Delay Time	10 seconds to 1440 minutes
Output Time Limit	0 = ∞, 1 to 1440 minutes
Hand Time Limit	0 = ∞, 1 to 1440 minutes

Relay Output Menu – Target PPM Feed

Makeup Conductivity	Full scale range of the parameter
Unit Volume to Trigger Output	1 to 999,999,999 (units defined by user)
Target PPM Set Point	0 to 100,000 ppm
Specific Gravity of Chemical Fed	0 to 10.000 g/ml
Pump Flow Rate	0 to 1,000 (units defined by user)
Output Time Limit	0 = ∞, 1 to 1440 minutes
Hand Time Limit	0 = ∞, 1 to 1440 minutes

Relay Output Menu – Target PPM Feed with Feed Verification

Makeup Conductivity	Full scale range of the parameter
Unit Volume to Trigger Output	1 to 999,999,999 (units defined by user)
Target PPM Set Point	0 to 100,000 ppm
Specific Gravity of Chemical Fed	0 to 10.000 g/ml
Output Time Limit	0 = ∞, 1 to 1440 minutes
Hand Time Limit	0 = ∞, 1 to 1440 minutes

4-20 mA Output Menus

(parameter selected) = 4 mA	Full scale range of the parameter
(parameter selected) = 20 mA	Full scale range of the parameter

Full Scale Ranges are:

Contacting Conductivity:	0 to 10,000 μ S/cm
Electrodeless Conductivity:	50 to 10,000 μ S/cm
Or	10 mS/cm to 100 mS/cm
Or	100 mS/cm to 1000 mS/cm
Temperature:	-18 to 200 degrees C
pH:	-2 to 16 standard units
ORP:	-1400 to 1400 mV
Chlorine, Chlorine Dioxide	0 to 10 mg/l

Data Logging Menu

Logging Interval	10 to 1440 minutes
------------------	--------------------

3.0 UNPACKING & INSTALLATION

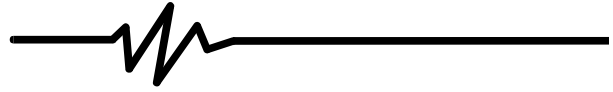

3.1 Unpacking the Unit

Inspect the contents of the carton. Please notify the carrier immediately if there are any signs of damage to the controller or its parts. Contact your distributor if any of the parts are missing. The carton should contain a WebMasterONE and technical support package (contains instruction manual, Quick Start Guide, CD and USB cable). Any options or accessories will be incorporated as ordered.

3.2 Mounting the Electronic Enclosure

The WebMasterONE is supplied with mounting holes on the enclosure. It should be wall mounted with the display at eye level on a vibration-free surface, utilizing all mounting holes for maximum stability.

The enclosure is NEMA 4X rated, suitable for outdoor installation. The maximum ambient operating temperature is 120 degrees F (49 degrees C); this should be considered if installation is in a high temperature location.

The installation site should be in close proximity to grounded AC power, the chemistry to be controlled, and phone line or Ethernet hub (if applicable).

Avoid locations that are in close proximity to sources of electrical noise (motor starters, power transformers, variable speed motor drives, radio transmitters, etc.), corrosive fumes or excessive moisture.

The enclosure requires the following clearances:

Top:	2"
Left:	10"
Right:	4"
Bottom:	8"

3.3 Installation

Plumbing

The WebMasterONE series controllers are supplied with a flow switch manifold designed to provide a continuously flowing sample of cooling water to the sensors. Please refer to Figures 1 (a-d) below for some typical installation drawings.

Cooling Towers:

Tap off the discharge side of the recirculation pump to provide a minimum flow of 1 gallon per minute through the flow switch manifold. The sample must flow into the bottom of the manifold in order to close the flow switch, and return to a point of lower pressure in order to ensure flow. Install an isolation valve on both sides of the manifold to stop flow for sensor maintenance.

IMPORTANT: To avoid damaging the female pipe threads on the supplied plumbing parts, use no more than 3 wraps of PTFE tape and thread into the pipe FINGER tight only! DO NOT use any pipe dope, plumber's putty or other sealing products that contain diacetone alcohol, as these attack the flow switch plastic! Use PTFE tape ONLY!

Boilers:

The conductivity probe should be placed as close to the controller as possible, to a maximum distance of 250 ft. The cable **MUST** be shielded from background electrical noise. Use 24 AWG, 3 twisted pair, shielded, low capacitance (15 pF/ft) cable such as Walchem P/N 102535 (Belden 9680) or equivalent.

Important Boiler Installation Notes: (see figure 1b and c)

- 1. Make sure the minimum water level in the boiler is at least 4-6 inches above the skimmer blowdown line. If the skimmer line is closer to the surface, it is likely that steam will be drawn into the line instead of boiler water. The skimmer line must also be installed above the highest tube.**
- 2. Maintain a 3/4 inch minimum pipe ID with no flow restrictions from the tap for the boiler skimmer blowdown line to the electrode. If the ID is reduced below 3/4 inch, then flashing will occur beyond that point and the conductivity reading will be low and erratic. Minimize the usage of tees, valves, elbows or unions between the boiler and the electrode.**
- 3. A manual shut off valve should be installed so that the electrode can be removed and cleaned. This valve must be a full port valve in order to avoid a flow restriction. Keep the distance between the tap for the boiler skimmer line to the electrode as short as possible, to a maximum of 10 feet.**
- 4. Mount the electrode in the side branch of a tee in a horizontal run of pipe. This will minimize entrapment of steam around the electrode and will allow any solids to pass through.**
- 5. There MUST be a flow restriction after the electrode and/or control valve in order to provide back pressure. This flow restriction will be either a flow control valve or an orifice union. The amount of the flow restriction will affect the blowdown rate as well, and should be sized accordingly.**
- 6. Install the motorized ball valve or solenoid valve per the manufacturer's instructions.**
- 7. For best results, align the hole in the conductivity electrode such that the direction of water flow is through the hole.**

Guide to Sizing Blowdown Valves and Orifice Plates**1. Determine the Rate of Steam Production in Pounds per Hour:**

Either read off the boiler name plate (water-tube boilers) or Calculate from horsepower rating (fire-tube boilers):

HP x 34.5 = lbs/hr. Example: 100 HP = 3450 lbs/hr.

2. Determine the Concentration Ratio (BASED ON FEEDWATER)

A water treatment chemical specialist should determine the desired number of cycles of concentration. This is the ratio of TDS in the boiler water to TDS in the feedwater. Note that feedwater means the water that is fed to the boiler from the deaerator and includes makeup water plus condensate return.

Example: 10 cycles of concentration has been recommended

3. Determine the Required Blowdown Rate in Pounds Per Hour

Blowdown Rate = Steam Production / (Concentration Ratio - 1)

Example: $3450 / (10 - 1) = 383.33$ lbs./hr

4. Determine if Continuous or Intermittent Sampling is Required

Use intermittent sampling when the boiler operation or loading is intermittent, or on boilers where the required blowdown rate is less than 25% of the smallest available flow control valve or less than the flow through the smallest orifice. See the graphs on the next page.

Use continuous sampling when the boiler is operating 24 hours per day and the required blowdown rate is more than 25% of the smallest applicable flow control valve or orifice. See the graphs on the next page.

Use of a flow control valve will give you the best control of the process, since the flow rate can be easily adjusted. The dial on the valve also gives you a visual indication if the flow rate has been changed. If the valve clogs, it can be opened to clear the obstruction, and closed to the previous position.

If an orifice plate is used, you must install a valve downstream from the orifice in order to fine tune the flow rate and provide additional back pressure in many applications.

Example: An 80 psi boiler has a Required Blowdown Rate of 383.33 lbs./hr. The maximum flow rate of the smallest flow control valve is 3250 lbs./hr. $3250 \times 0.25 = 812.5$ which is too high for continuous sampling. Using an orifice, the flow rate through the smallest diameter plate is 1275 lbs./hr. This is too high for continuous sampling.

5. Determine the Orifice or Flow Control Valve Size for this Blowdown Rate

Use the following graphs to select a flow control device:

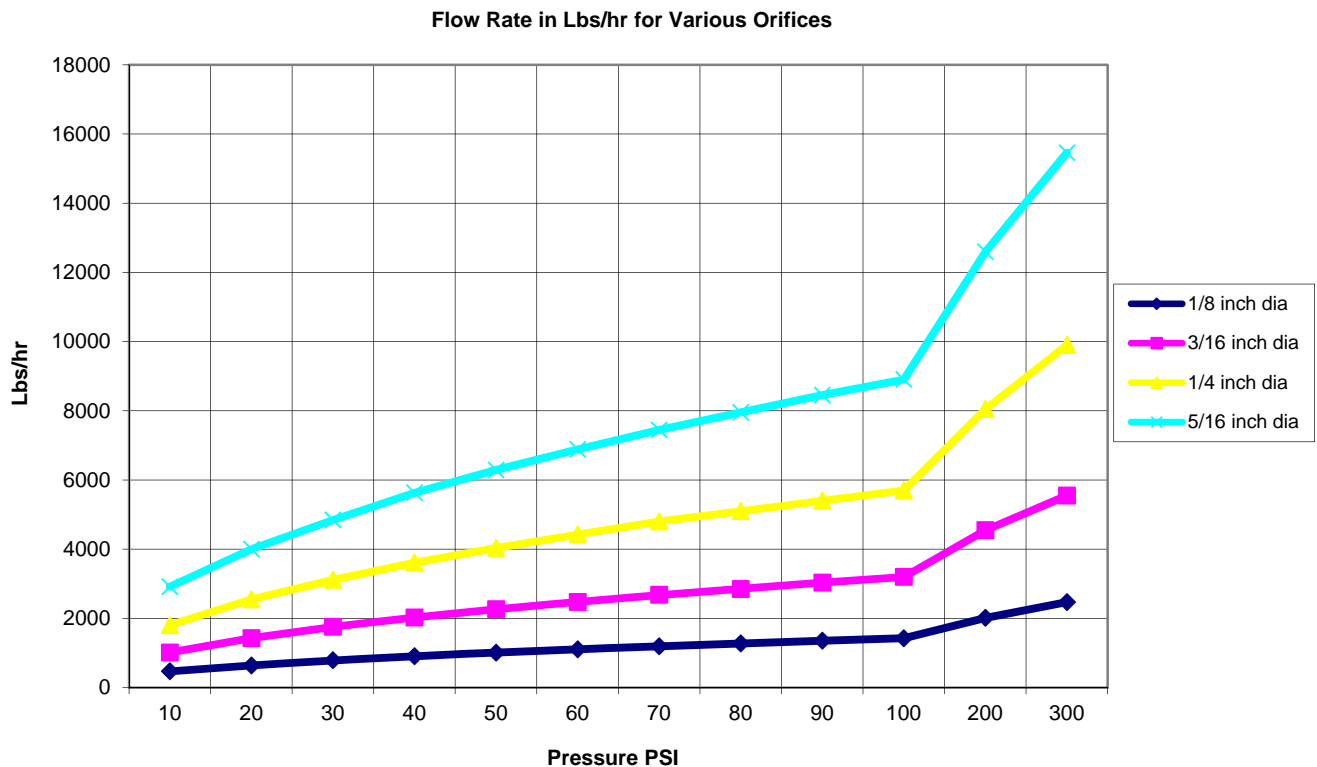

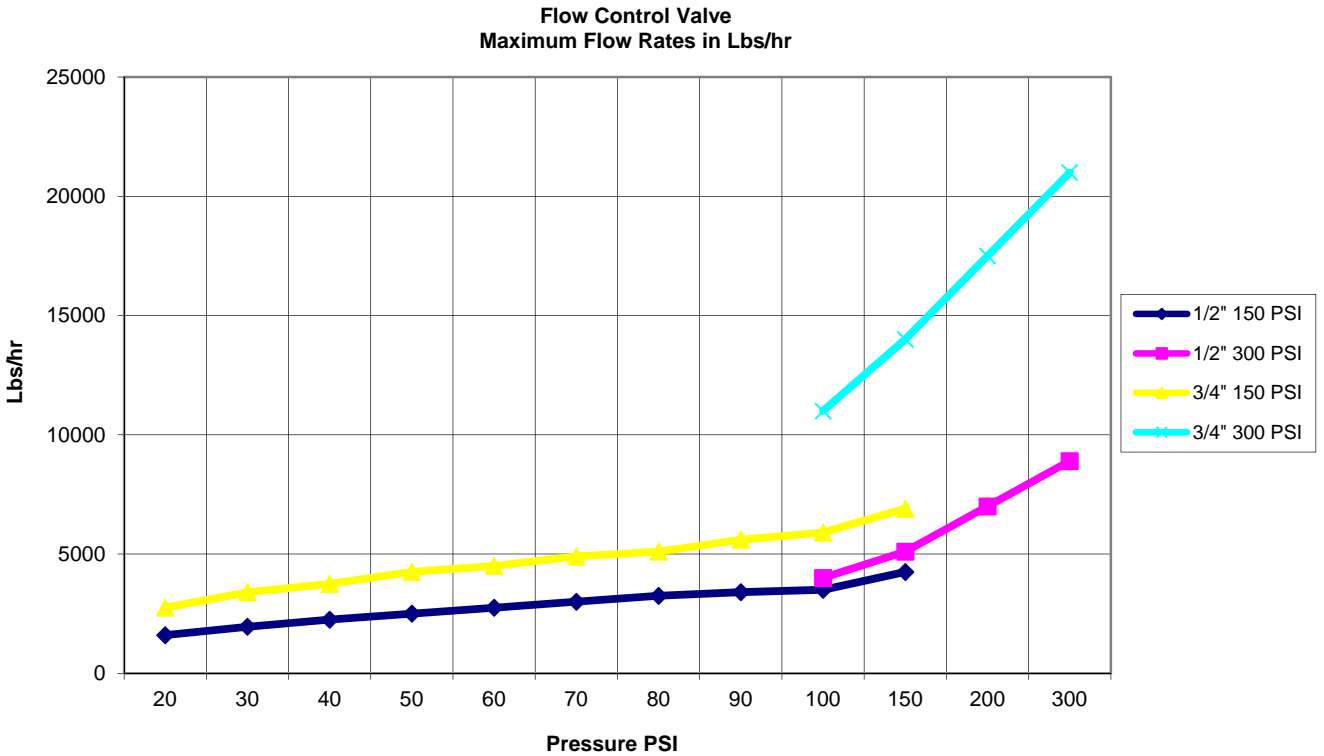

Sensor Installation

All sensors for the WebMasterONE series are provided with signal conditioning electronics, and conductivity sensors may be located up to 250 feet (75 meters) from the controller, and pH/ORP sensors may be located up to 1000 feet (303 meters) from the controller. It is highly recommended that the sensors be installed within 20 feet of the controller in order to make periodic calibration more convenient.







Sensors should be located such that they respond rapidly to a well-mixed sample of the process water and the treatment chemicals. If they are too close to the chemical injection point, they will see spikes in concentration and cycle on and off too frequently. If they are too far away from the chemical injection point, they will respond too slowly to the concentration changes, and you will overshoot the set point.

If the sensor cables need to be extended, then 24 AWG shielded low capacitance (15 pF/ft) twisted pair cable such as Walchem P/N 102535 (Belden 9680) or equivalent should be used. Pay attention to the integrity of the cable shield. Always route sensor cables (or any other low voltage wiring) in conduit that is separated from any AC voltage wiring by at least 6 inches.

pH and ORP electrodes must be installed such that the measuring surfaces will always remain wet. A U-trap provided in the manifold design should achieve this, even if the sample flow stops. These electrodes also must be installed with the measuring surfaces pointing down; that is 5 degrees above the horizontal, at a minimum.

If the sensors are to be submersed in the process, mount them firmly to the tank, and protect the cable with plastic pipe, sealed at the top with a cable gland, to prevent premature failure. Place the sensors in an area of good solution movement.

3.4 Icon Definitions

Symbol	Publication	Description
	IEC 417, No.5019	Protective Conductor Terminal
	IEC 417, No. 5007	On (Supply)
	IEC 417, No. 5008	Off (Supply)
	ISO 3864, No. B.3.6	Caution, risk of electric shock
	Pending	Caution, High temperature, risk of burn
	ISO 3864, No. B.3.1	Caution

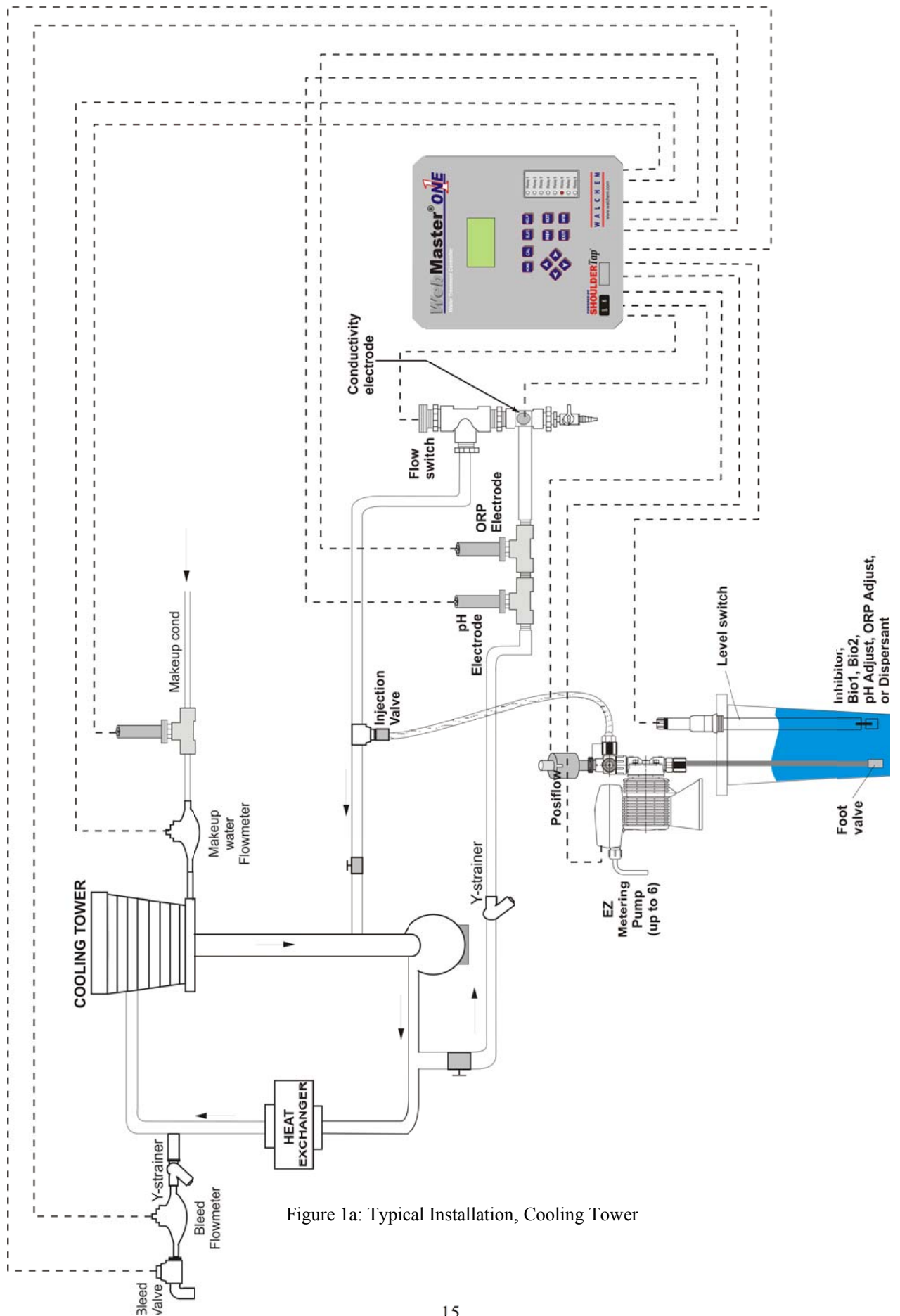

Figure 1a: Typical Installation, Cooling Tower

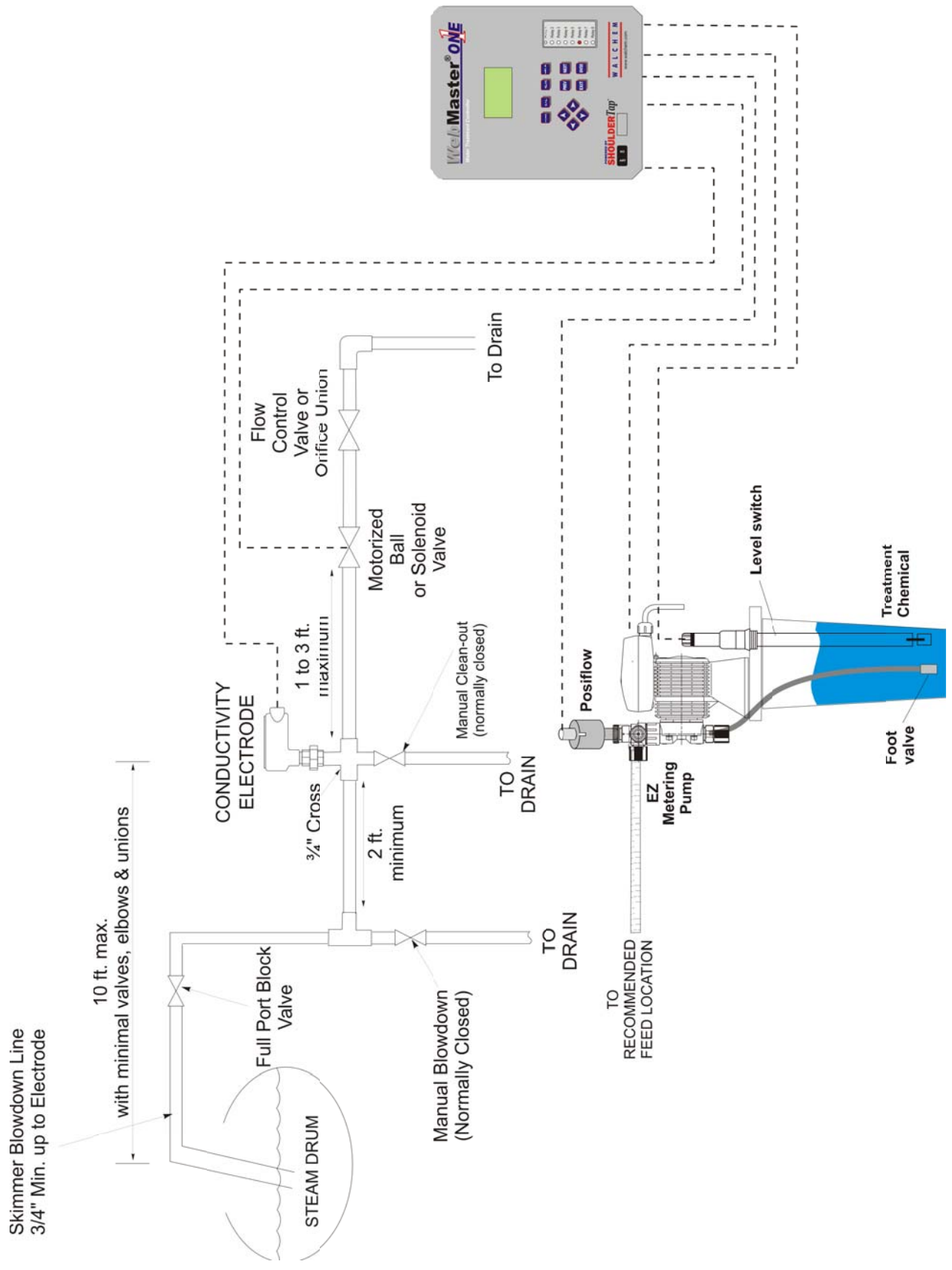

Figure 1b Typical Installation, Boiler Intermittent Sampling

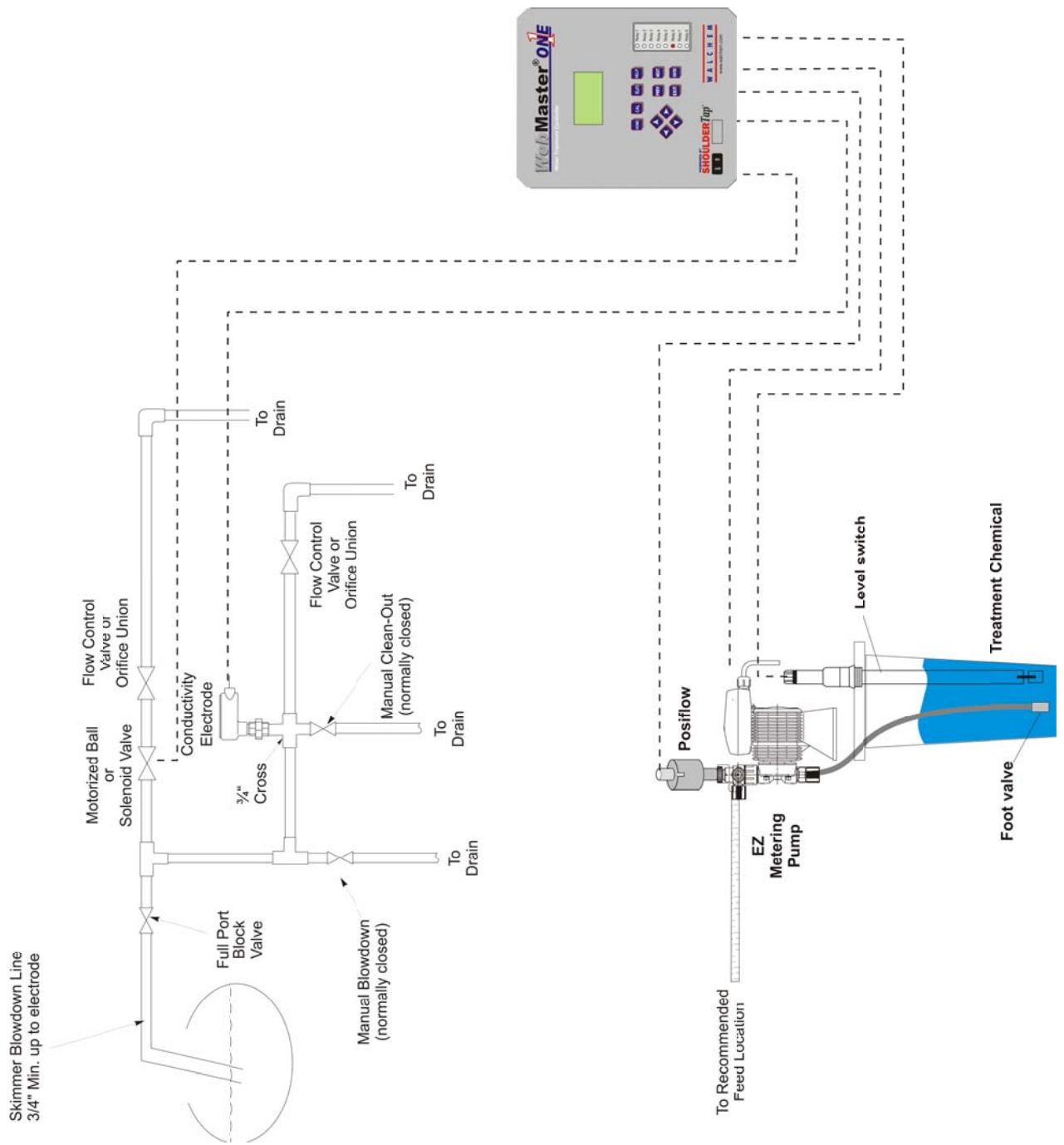

Figure 1c: Typical Installation, Boiler Continuous Sampling

3.5 Electrical Installation

The WebMasterONE series controllers require the following voltages:

100 –120/200-240 VAC± 10%, 50/60 Hz, 12 amperes maximum

The controller must be connected to its own 15 ampere breaker, close by, to act as an alternate power shutdown.

Your controller is supplied either factory prewired or ready to be hardwired. Depending upon your choice of options, you may be required to hardwire some or all of the input/output devices. Please refer to Figures 4 through 8 for wiring diagrams.

The output loads may be connected to pigtail (125V prewired) connections or terminal block (hardwired) connections. The total output current must not exceed 11 amps. The output relays are connected in two relay banks each fused at 6.3 amps. See figure on the right. Assess the steady state amps of all loads before connecting to controller. Depending upon your model code, some relays may be dry contact and not fused.

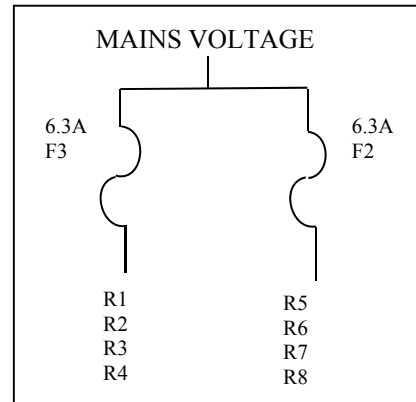

CAUTION! There are live circuits inside the controller even when the power switch on the front panel is in the OFF position! The front panel must never be opened before power to the controller is REMOVED!

If your controller is prewired, it is supplied with a 10 foot, 14 AWG power cord with USA style plug and 8 inch, 18 AWG USA style receptacle cords for the powered relay outputs. A tool (#1 Phillips driver) is required to open the front panel.



CAUTION! The electrical installation of the controller must be done by trained personnel only and conform to all applicable National, State and Local codes!

Note: Many of the inputs and outputs listed are optional and may not be present in your controller.

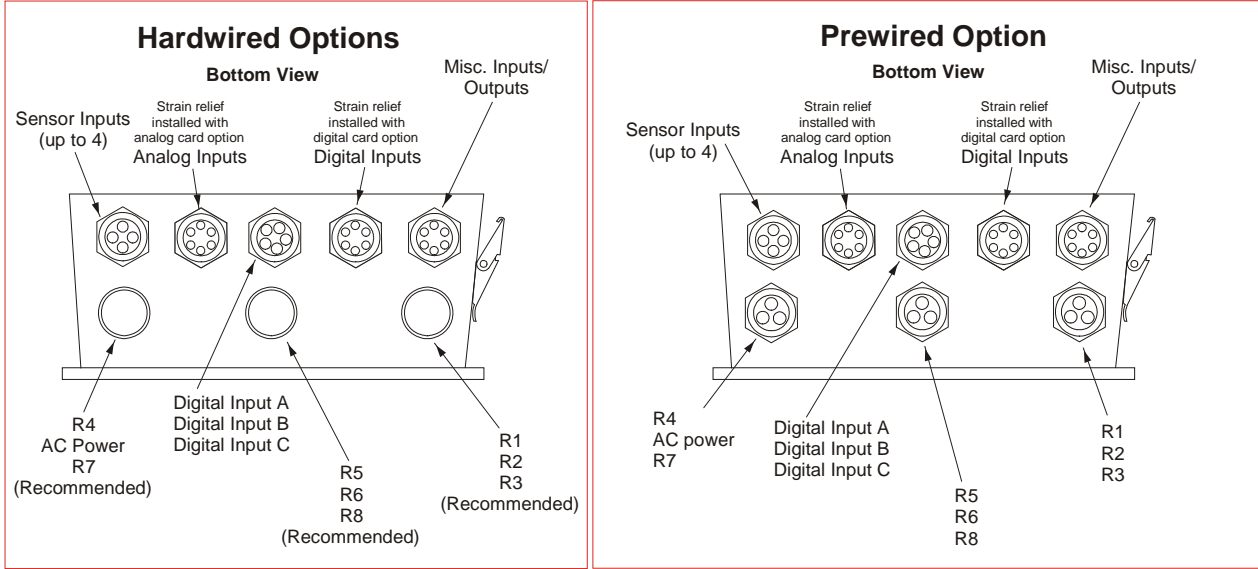

Figure 2: Conduit/Wiring Configuration

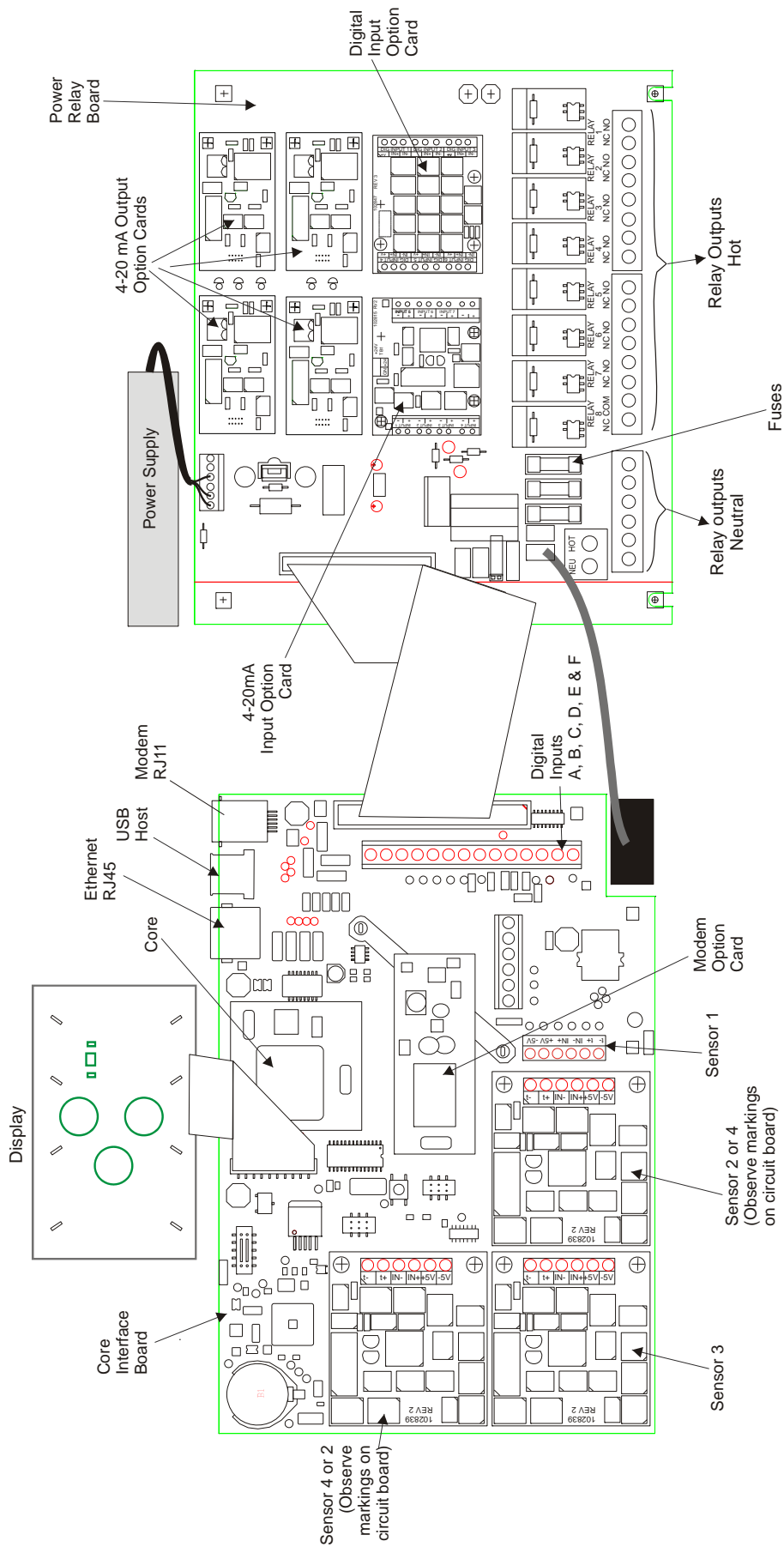

Figure 3 Identification of Parts

VoltageCode	R1	R2	R3	R4	R5	R6	R7	R8
0 or 4	DRY	DRY	DRY	DRY	DRY	DRY	DRY	DRY
1 or 6	POWERED	POWERED	POWERED	POWERED	POWERED	POWERED	POWERED	DRY
2 or 5	POWERED	POWERED	POWERED	POWERED	POWERED	POWERED	POWERED	POWERED
3 or 7	DRY	POWERED	DRY	POWERED	DRY	POWERED	DRY	POWERED

DRY CONTACTS WILL BE LABELED COM INSTEAD OF NC.

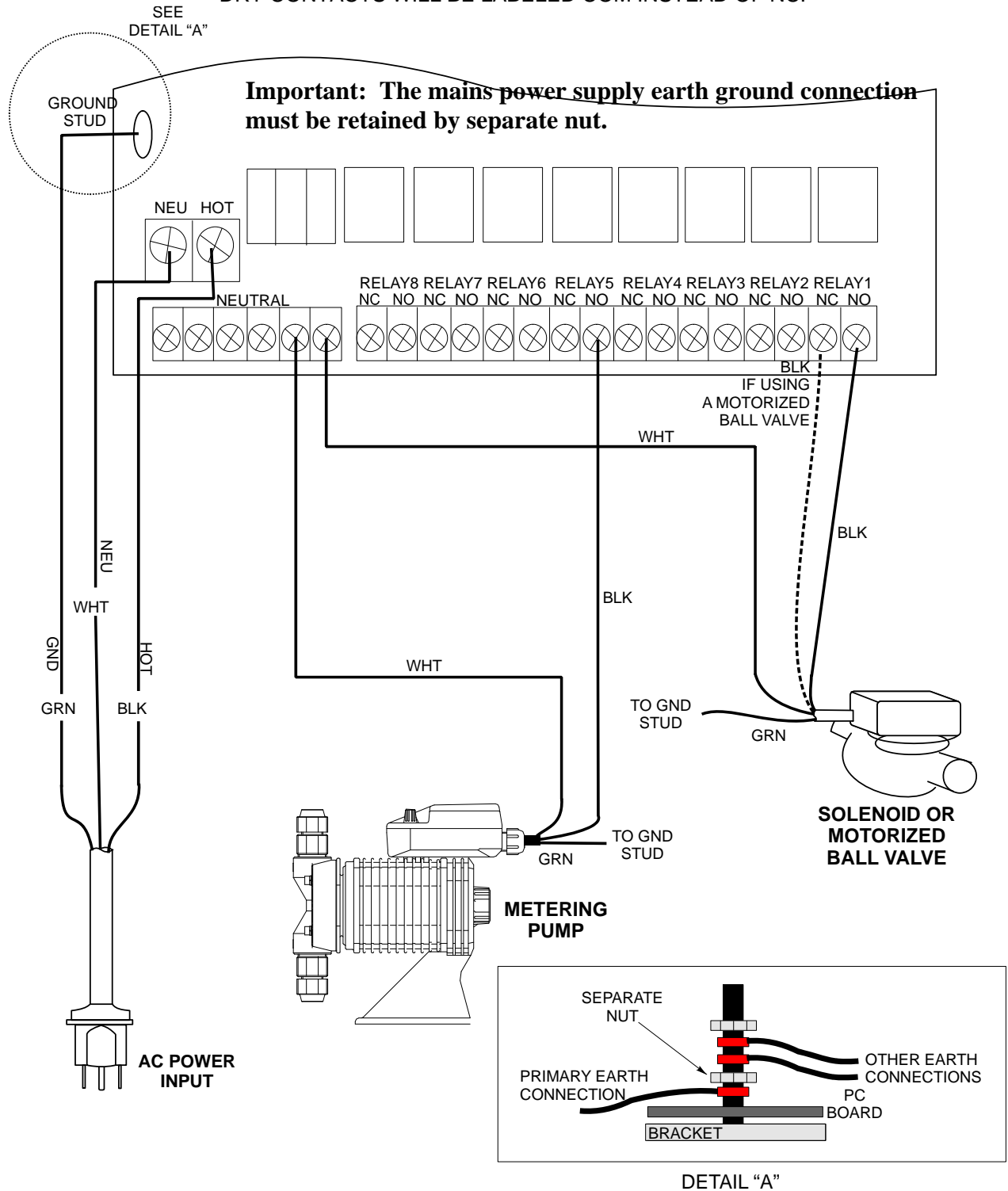

Figure 4: Wiring Diagram for AC Power Input and Relay Outputs

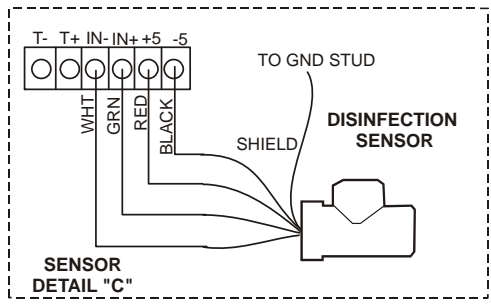
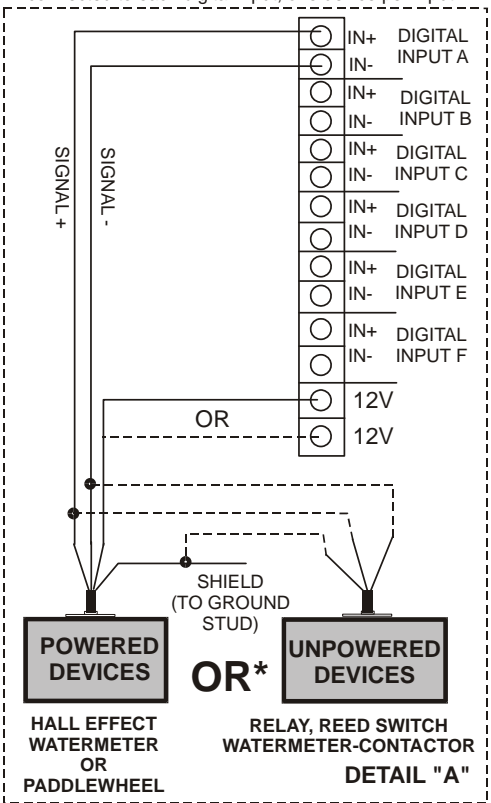
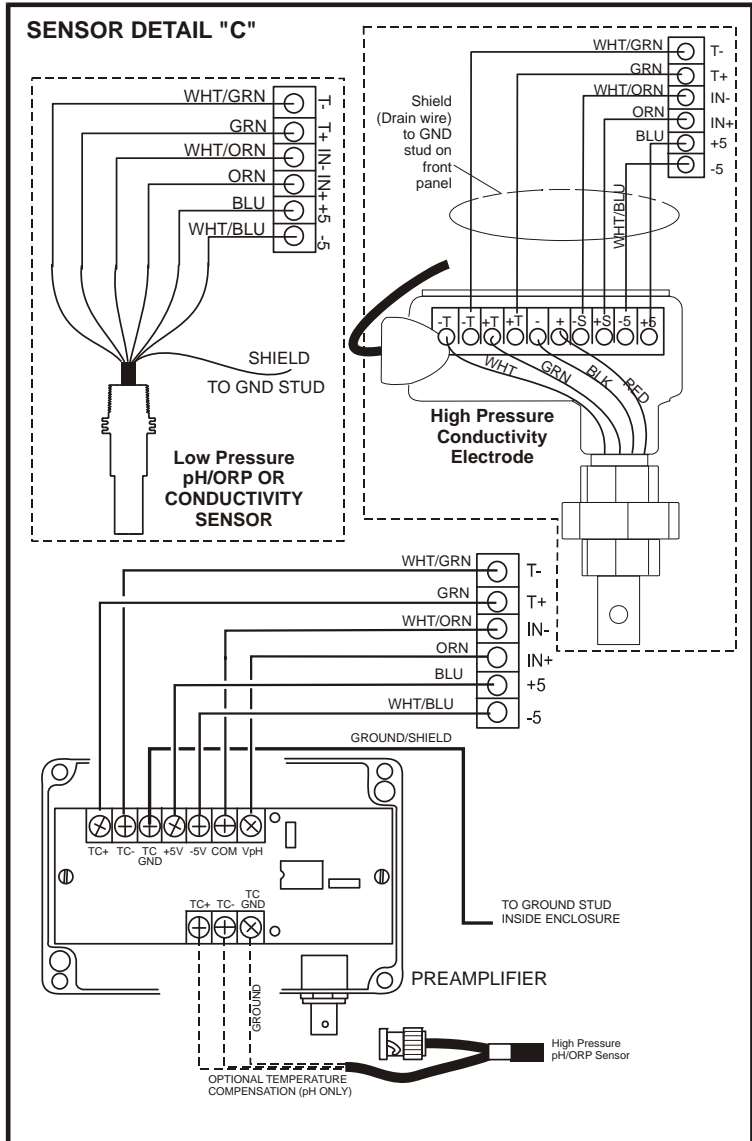
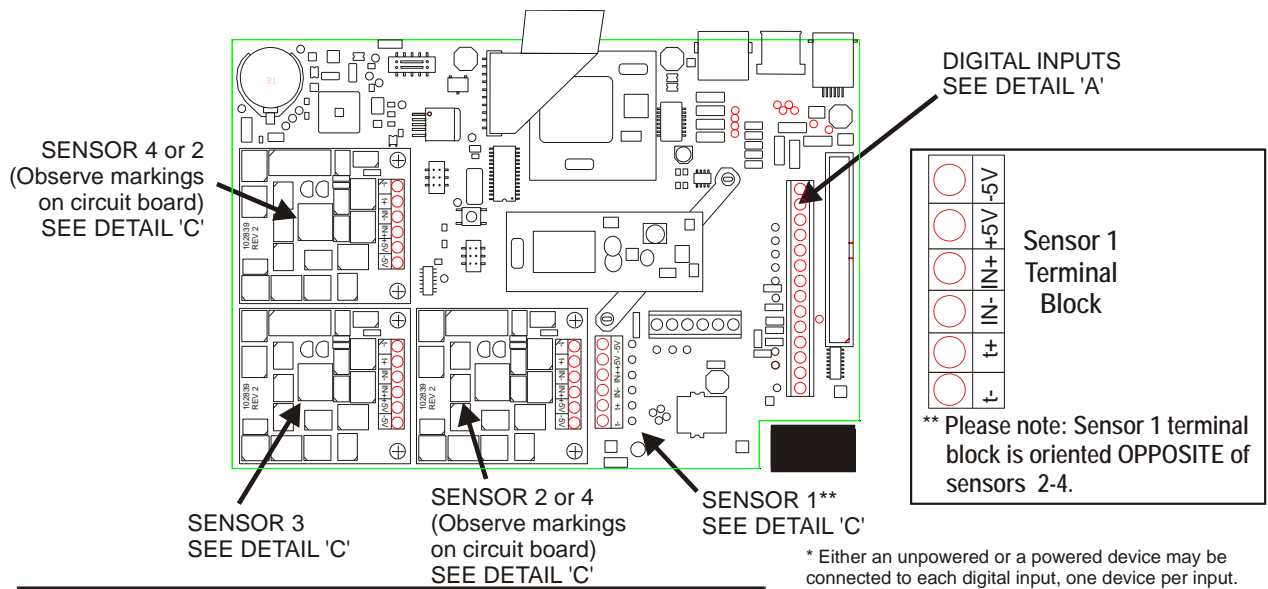
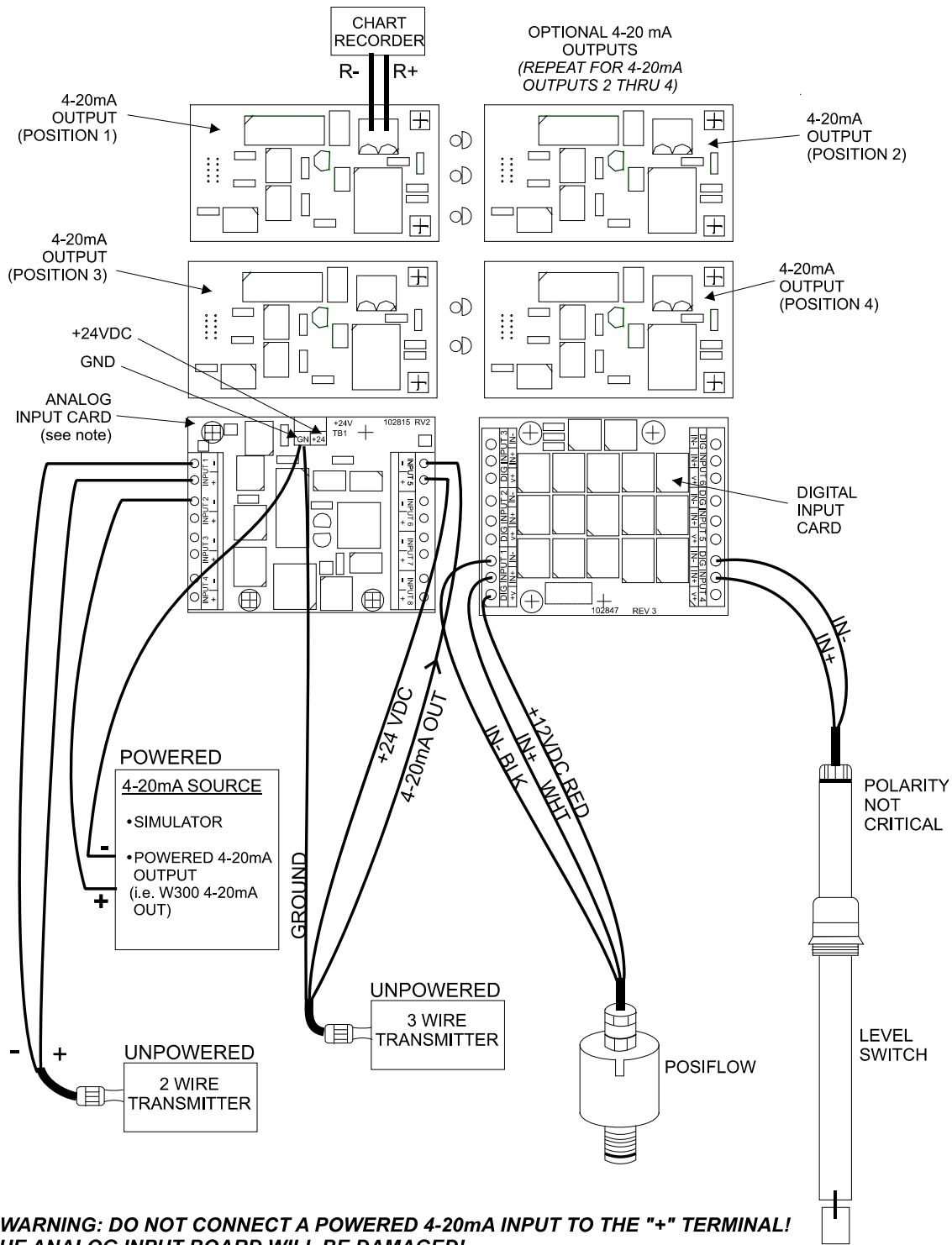

Figure 5: Wiring Diagram for Sensor Inputs and Digital Inputs A-F



Note: The analog input card is group isolated. Do not connect more than one non-isolated transmitter without installing a signal isolator!

(See 4-20mA Wiring Guide on the following pages)

***Use shielded cable, grounded only at controller end, for ALL connections.**

Figure 6: Wiring Diagram for Optional Digital Inputs, 4-20 mA Inputs and 4-20 mA Outputs

WebMaster 4-20 mA Input Wiring Guide

KEY:

- A. (-) minus terminal is the signal input. The 4-20mA signal goes here.
- B. (+) plus terminal is a +24VDC power supply for the transmitters.
- C. GND terminal is the return for completing circuits, both signal and power.
- D. +24 terminal at the top middle of the board is the same supply as the (+) plus terminal.

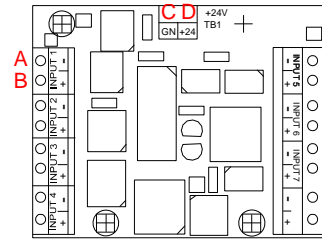

Use shielded cable, grounded only at the controller end, for all connections.

A. Two-Wire Loop-Powered Transmitter

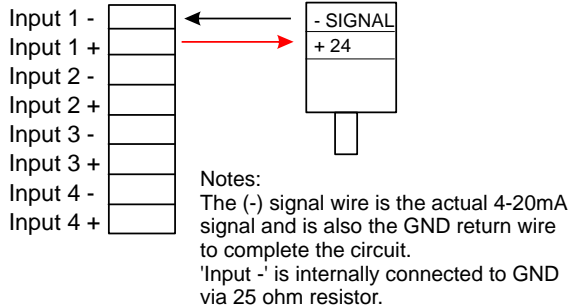

B. Two-Wire Externally-Powered Transmitter

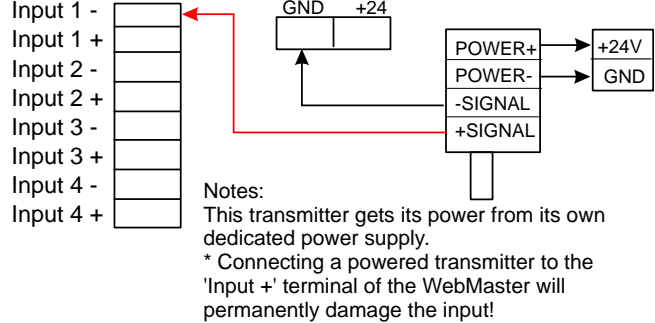

C. Three-Wire Transmitter

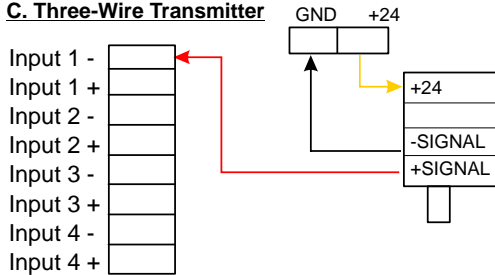

D. Four-Wire Transmitter

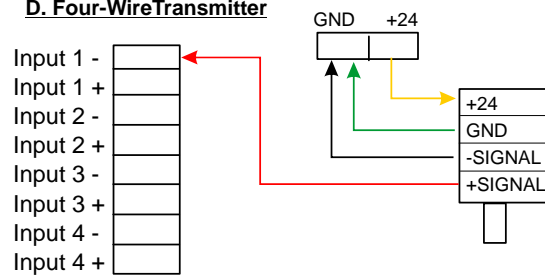

E. Non-Isolated Two-Wire Externally-Powered Transmitter

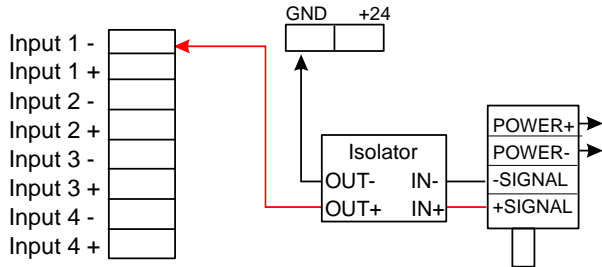

F. Non-Isolated Four-Wire Externally-Powered Transmitter

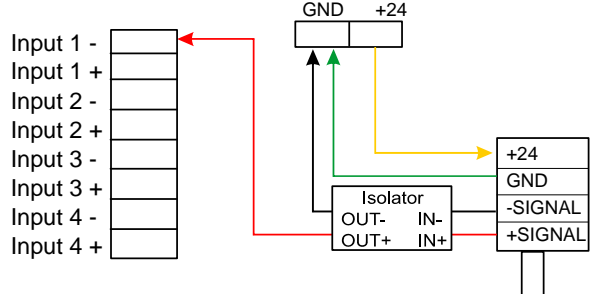

Notes:

The analog inputs share their negative terminals. They are all isolated from earth ground but not isolated from each other. One non-isolated device may be connected without problems. If more than one non-isolated transmitter is connected, they must be installed with an isolator.

ADDING AN ISOLATED RECEIVER TO THE LOOP (PLC, CHART RECORDER, ETC)
The WebMaster GND must always be at the bottom of the loop.
Maximum total loop resistance 1000 ohms.

A. Two-Wire Loop-Powered Transmitter

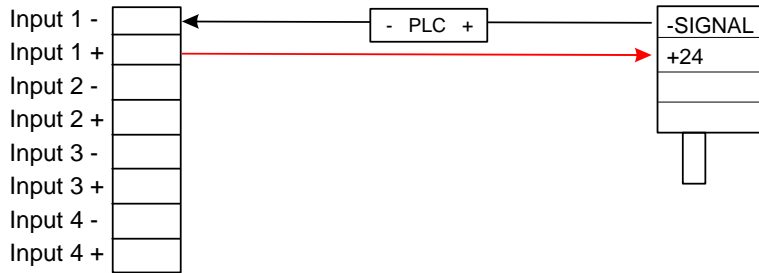

Notes:
 The (-) signal is the actual 4-20mA signal and is also the GND return wire to complete the circuit.

'Input -' is internally connected to GND via 25 ohm resistor.

B. Two-Wire Externally-Powered Transmitter

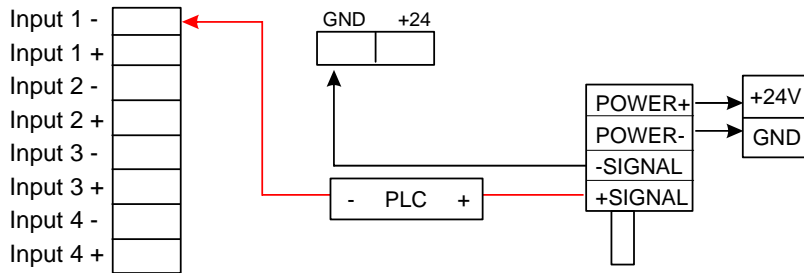

Notes:
 This transmitter gets its power from its own dedicated power supply.

* Connecting a powered transmitter to the 'Input +' terminal of the WebMaster will permanently damage the input!

C. Three-Wire Transmitter

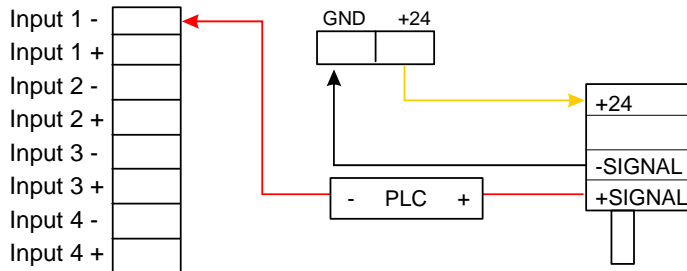

D. Four-Wire Transmitter

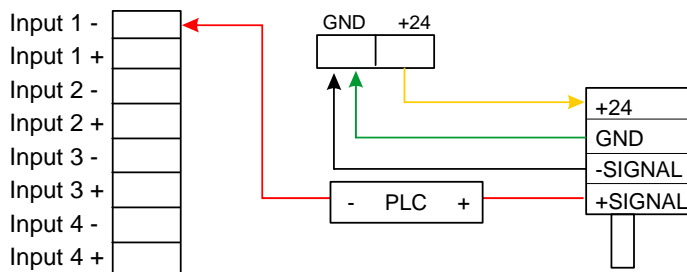

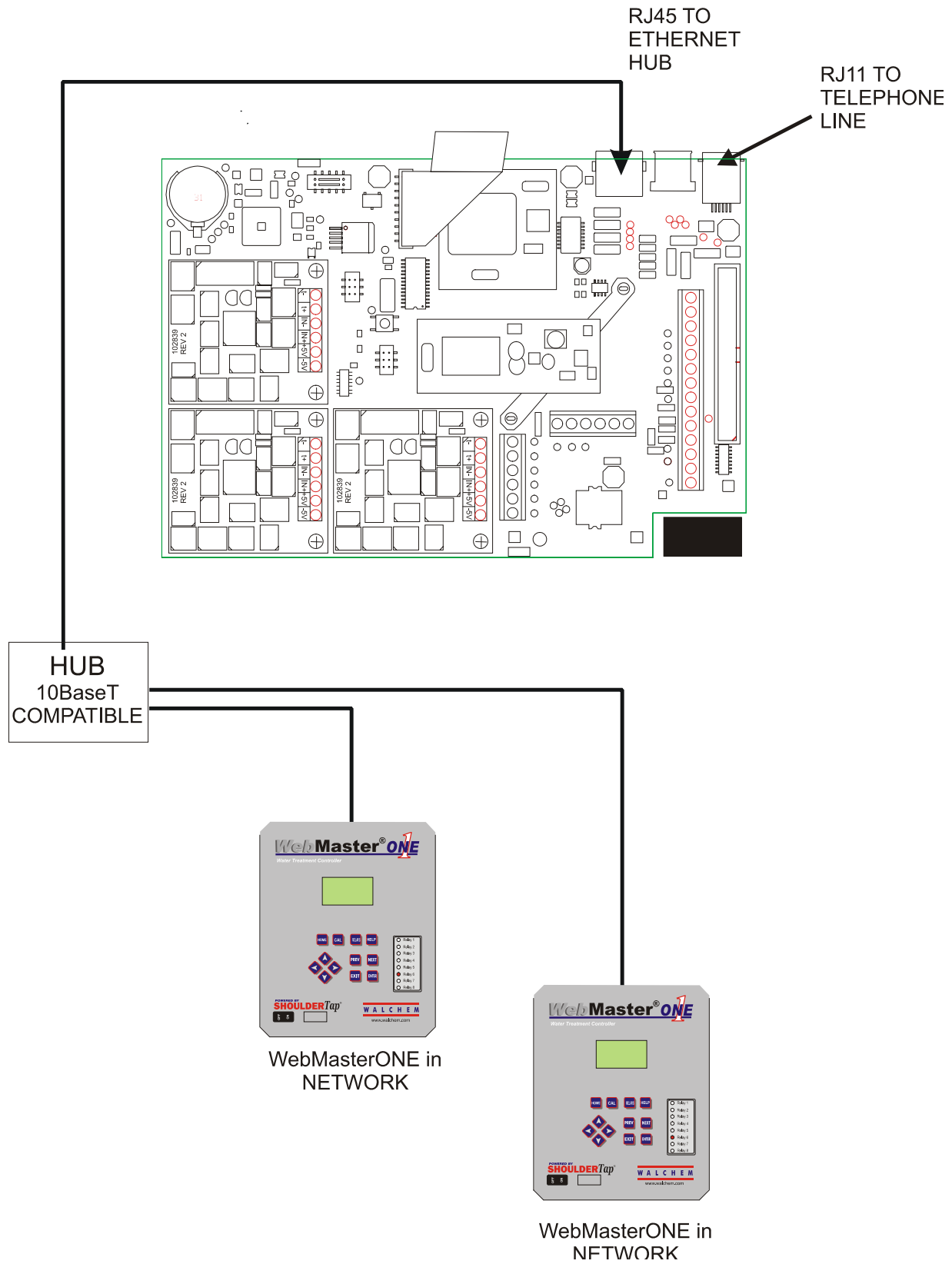
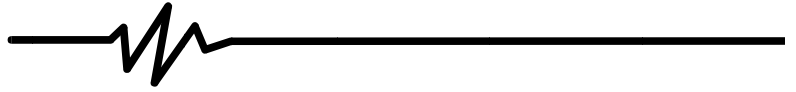

Figure 7: Wiring Diagram for Optional Digital Communications

4.0 FUNCTION OVERVIEW



4.1 Front Panel

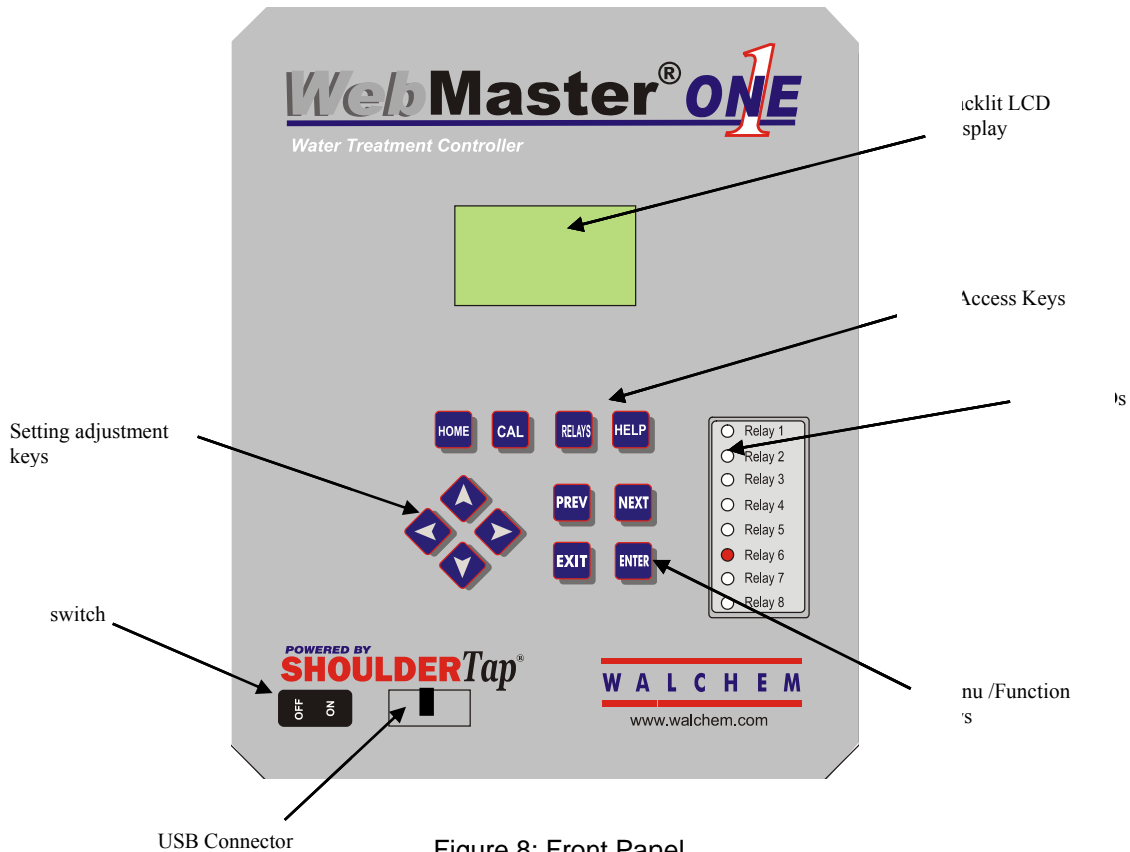

Figure 8: Front Panel

4.2 Display

Turn the power switch on. Be patient, the start up sequence will take about the same time as it takes a computer to boot up, approximately 2 minutes. At first the display backlight will blink and all output LEDs will light. Around 30 seconds later, the display backlight will come on, and the LEDs will shut off. Then the display will come up, and show you the % complete status of the start up process. After around 1 minute, the Summary Screen will appear. In 15 seconds, you will hear 3 beeps, and the controller is ready to go.

The Summary Screen will display the sensor inputs, analog inputs, PPM, etc (up to 5 parameters selected from the Startup web page) and the most significant active alarm. Any additional alarms may be viewed by pressing the Down Arrow key.



Figure 9: Display

4.3 Keypad

The keypad consists of 4 directional arrow keys (up, down, left and right), 4 menu/function keys (previous, next, exit and enter), and 4 quick access keys (home, calibrate, relays, and help).

The arrow keys are used to change settings (up and down) and move the cursor to a different location within that menu in order to change that setting (left and right).

The function keys are used to navigate through the different menu selections. The Next and Prev keys move you from menu to menu. The Enter key is used to enter a submenu, and to accept a new setting. The Exit key is used to back up one menu level. No matter where you are in the menus, pressing Exit enough times will bring you to the Summary Screen (or press Home, see below).

To change a numeric value, move the cursor to the digit you want to change by pressing the left or right arrow keys, then use the up or down arrow keys to change the value. Press the Enter key after all digits have been changed to enter the new value into memory. Similarly, to change an alphanumeric value, use the up or down arrow keys to change that character, and the left and right arrow keys to move to the next character. Press the Enter key after all characters have been changed.

The quick access keys bring you directly to frequently used or critical functions. The Home key will bring you directly back to the Summary Screen. The CAL key will bring you directly to the sensor calibration menus. The Relays key will bring you directly to menus that allow you to force the relays off or on. The Help key is under construction. Refer to Section 5.0 for details on use of the keypad for sensor calibration, relay control, setting communications parameters, etc.

4.4 Access Codes

The WebMasterONE series controller is shipped with the access codes at default values. In order to prevent against unauthorized tampering, you will need to change the access codes to your own values. See section 6.50 for details.

There are three levels of protection. If the *Master* password is used in the WebMasterONE Authentication page, then any set point can be changed. The default Master password is 2001.

If the *Calibration* password is used in the Authentication page, then sensor calibrations will be allowed, but other changes will not. The default Calibration password is 2002.

If the *Read Only* password is used the user will be able to look at any page, but will not be allowed to make any changes. The default Read Only is 2003.

The default user name is "webmaster." This can and should be changed in the Access Code page. See section 6.50 for details.

4.5 Initial Startup

Turn the power switch on. Be patient, the start up sequence will take about the same time as it takes a computer to boot up, approximately 2 minutes. At first the display backlight will blink and all output LEDs will light. Around 30 seconds later, the display backlight will come on, and the LEDs will shut off. Then the display will come up, and show you the % complete status of the start up process. After around 1 minute, the Summary Screen will appear. In 15 seconds, you will hear 3 beeps, and the controller is ready to go.

The WebMasterONE Series controllers have a wide range of capabilities, so the steps required preparing the site for installation would be different depending upon the capability you will be using.

Currently the WebMasterONE has only limited functionality for the local display and keypad. ALL of the programming must be accomplished using a computer.

You will be able to calibrate all sensor inputs, change access codes, and enter the information necessary to communicate with the WebMasterONE via an Ethernet connection or via the modem over the Internet (if a modem card is installed in the controller). If neither of these communications options are installed, you must use an USB connection to a PC for programming. You may set most set points with the keypad, but you may not change operating modes (for example, you may change the pump on time for a time-based add, but not the time of day; nor can you change from a 1 week cycle to a 2 week cycle).

If you have a stand-alone controller with no communications, but you do have a computer to connect to the USB port on the front panel of the controller for programming, go to the section below called “Connection via the USB Port”.

If you have a controller that is equipped with a modem, then you can take full advantage of the WebMasterONE. The controller is like a web server. Once you set up an Internet Service Provider (ISP) account for the controller, you can “surf” to the controller from any web connected computer to access data or reconfigure the controller. The controller can also contact you, by email or pager, in case of trouble. In this case, a dedicated analog phone line that does not go through a company switchboard for the controller must be provided. For details, go to the section below called “Remote Modem Access: Shoulder Tap.” The ISP information must be entered into the controller via the USB port, or via the local keypad before attempting a Shoulder Tap connection.

If you have not yet set up an ISP account and wish to program the WebMasterONE from a remote location, or if you just prefer the “old fashioned method” of direct modem-to-modem communication, go to the section below called “Direct Modem Access: Direct Tap.”

If you have the Ethernet connected, then the controller can become another PC on the network. You can use your web browser software, enter the controller’s address (assigned by your network administrator) and access data or reconfigure the controller. You will need to have a network node nearby to connect your WebMasterONE. See the section below called “Ethernet Connection to LAN”.

You may also use the Ethernet card in your laptop to communicate with the Ethernet card in the WebMasterONE. This requires a special null (crossover) cable and the Ethernet parameters must be programmed into the WebMasterONE using either USB or the local keypad. Refer to the section below called “Direct Ethernet (for an WebMasterONE not connected to the LAN).”

Uploading Configuration Files

You can save all of the set points from a previously programmed controller, and then upload the same set points into another controller. If you have already downloaded a configuration file from a previously programmed controller, you can upload that file to this controller in order to make all the set points the same. If you want to save the set points of this controller for use in future controllers, or want to program this controller using a stored configuration file, refer to section 6.48 for specific instructions.

See the appropriate section above, depending upon how you plan on uploading the configuration file; via a laptop connected to the front panel, via modem, via Ethernet connection, or via local PC connected to the USB port.

4.6 Communicating with the WebMasterONE

4.6.1 Connection via the USB Port

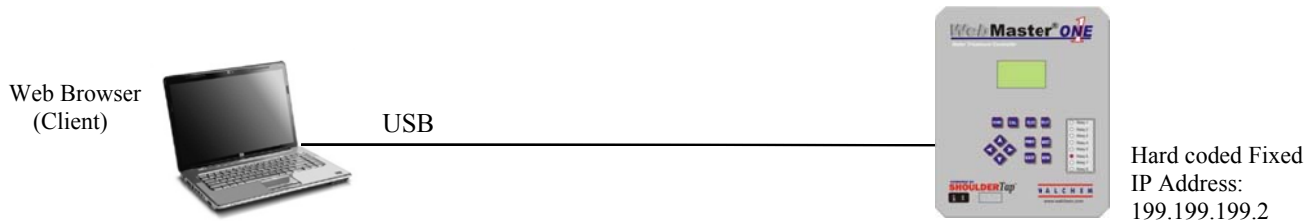

A USB connection to the WebMasterONE can be made via a temporary cable between a laptop and the front panel of the controller.

Equipment Required

- An USB cable with the appropriate connectors to connect your computer to the WebMasterONE.

Features Required in the WebMasterONE

- Any WebMasterONE controller is capable of an USB connection.

Utilities you need to set up on your computer

- You will need the USB driver, which comes with the WebMasterONE. It's also available on our Web site under Tech Support > WebMaster/WIND > Downloads and Upgrades. You will also need the Quick Start Guide which comes with the WebMasterONE, or you can download it from our Web site under Literature > WebMaster.

Parameters that need to be programmed into the WebMasterONE

- The WebMasterONE is capable of this type of communication without any programming by the user prior to attempting the communication.

Steps Required to Establish a Connection

- Connect the supplied USB cable between the WebMasterONE and your computer.
- Install the driver on your PC by inserting the disc supplied and following the instructions in the Quick Start Guide. This needs to be done only once for each PC that will be used to communicate with a WebMasterONE controller.
- Go to Control Panel, Network Connections, and locate the new Local Area Connection 2 that has been created. Click on the Properties button. Highlight Internet Protocol (TCP/IP) then click Properties. Click Use the following IP address and enter 199.199.199.1. Click OK to exit. This needs to be done only once for each PC that will be used to communicate with a WebMasterONE controller.
- Open Internet Explorer and type in the address 199.199.199.2. The sign-on screen for the WebMasterONE will come up.
- The sign-on screen of the WebMasterONE will come up. Type the User Name and Password (Access Code) in the text boxes and click the Submit button. The default user name is "webmaster" and the default passwords are "2001" for full access, "2002" for calibration only, and "2003" for read only. These defaults can and should be changed in the Access Code page.

4.6.2 Remote Modem Access: Shoulder Tap

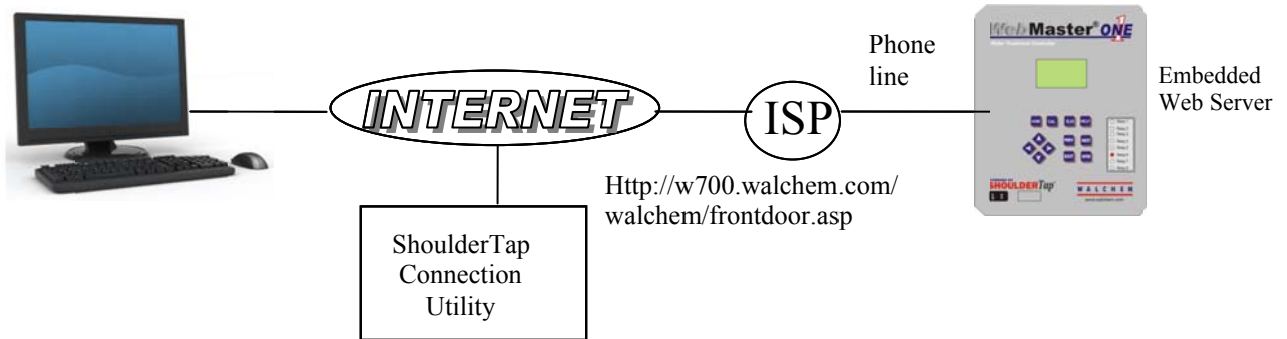

Equipment Required

- An Internet-ready computer.
- An active analog phone line, direct to the controller (without a PBX system in between) must be connected to the modem of the WebMasterONE.
- A dialup account must be established for the WebMasterONE with an Internet Service Provider (ISP). The connection will only be as reliable as the ISP. ISPs that require the installation of a CD cannot be used. Contact the factory for recommendations.

Features Required in the WebMasterONE

- The WebMasterONE must have the modem option installed in order to communicate via Shoulder Tap.

Utilities you need to set up on your computer

- There are no special drivers, adapters or other software components required on the PC.

Parameters that need to be programmed into the WebMasterONE

- Prior to attempting a Shoulder Tap connection, the following information needs to be entered into the Communications page of the WebMasterONE, either via an USB connection, direct modem connection (Direct Tap) or via the local keypad. Some of this information needs to be provided to you by the Internet Service Provider (ISP) that the WebMasterONE will use to access the Internet.
- The controller's phone number.
- The local access phone number for the ISP. More than one access number may be entered.
- The ISP Username that the controller will use to connect to the ISP.
- The ISP Password that the controller will use to connect to the ISP.

Steps Required to Establish a Connection

- Connect your PC to the Internet.
- Enter the address <http://w700.walchem.com/walchem/frontdoor.asp>.
- Click the link "Log onto WebMasterONE", which will bring you to the WebMasterONE Connection Utility Authentication Page.
- Enter the Connection Utility Username (WebMaster) and Password (2001) and click the Submit button.
- Enter the phone number of the controller and click the Connect button. After a few minutes, the sign-on screen for the WebMasterONE will come up.
- The sign-on screen of the WebMasterONE will come up. Type the User Name and Password (Access Code) in the text boxes and click the Submit button. The default user name is "webmaster" and the default passwords are "2001" for full access, "2002" for calibration only, and "2003" for read only. These defaults can and should be changed in the Access Code page.

4.6.3 Ethernet Connection to LAN

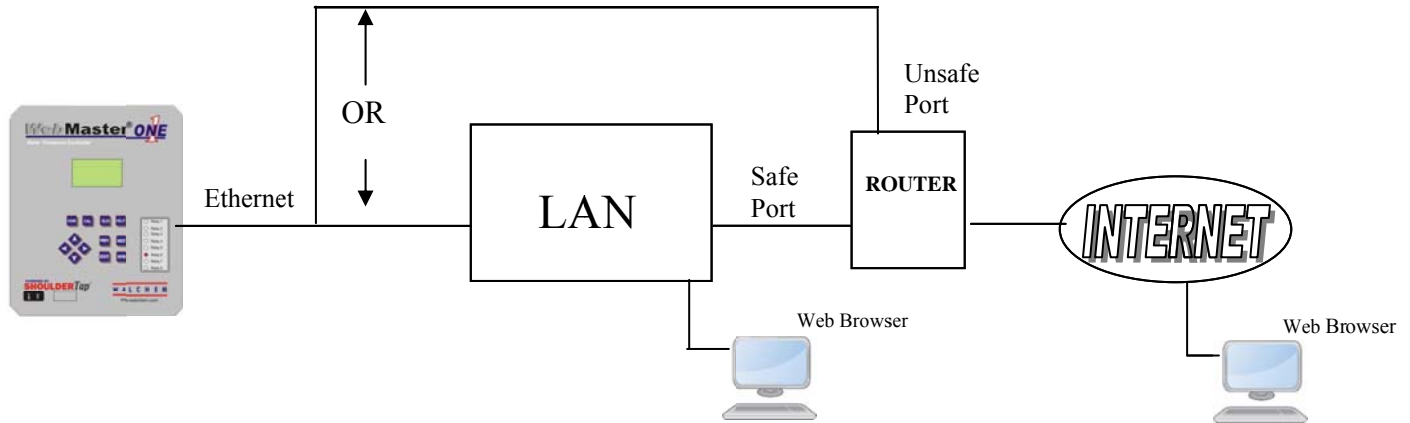

Equipment Required

- An Internet-ready computer.
- A connection between the PC and the local area network (LAN).
- An Ethernet connection between the WebMasterONE and the LAN.

Utilities you need to set up on your computer

- There are no special drivers, adapters or other software components required on the PC.

Parameters that need to be programmed into the WebMasterONE

- Prior to attempting an Ethernet connection, the following information needs to be entered into the Communication page of the WebMasterONE, either via an USB connection or via the local keypad. This information must be provided by the IT Administrator of the LAN.
- The Ethernet IP address of the WebMasterONE. If the controller will only be accessed by computers on the LAN then this may be a local IP address. If the controller needs to be accessible by computers not on the LAN then this must be an Internet accessible IP address.
- The Subnet Mask.
- The Gateway IP address.

Steps Required to Establish a Connection

- Open Internet Explorer.
- Type in the Ethernet IP address that has been assigned by the IT Administrator.
- The sign-on screen of the WebMasterONE will come up. Type the User Name and Password (Access Code) in the text boxes and click the Submit button. The default user name is "webmaster" and the default passwords are "2001" for full access, "2002" for calibration only, and "2003" for read only. These defaults can and should be changed in the Access Code page.

4.6.4 Direct Modem Access: Direct Tap

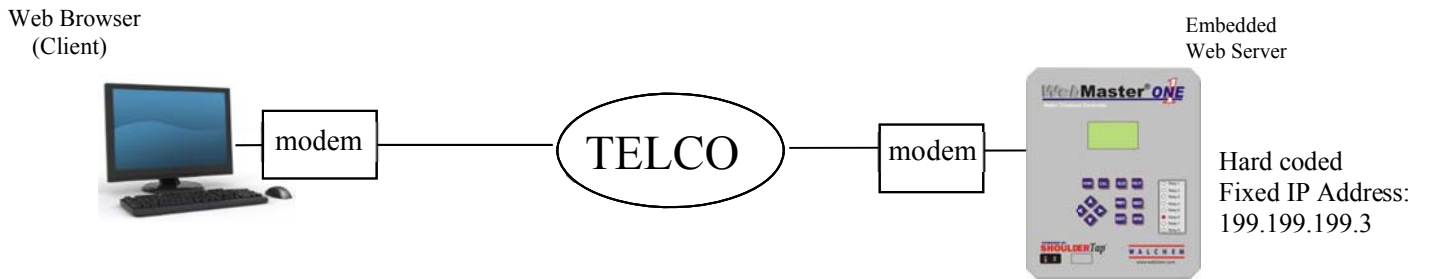

Equipment Required

- An Internet-ready computer.
- An active analog phone line, direct to the controller (without a PBX system in between) must be connected to the modem of the WebMasterONE.

Features Required in the WebMasterONE

- The WebMasterONE must have the modem option installed in order to communicate via Direct Tap.

Utilities you need to set up on your computer

- A Windows dialup networking adapter must be created. Refer to the Quick Start Guide instructions for this procedure.

Parameters that need to be programmed into the WebMasterONE

- The WebMasterONE is capable of this type of communication without any programming by the user prior to attempting the communication.

Steps Required to Establish a Connection

- Create the dialup networking adapter on your PC. This needs to be done only once for each PC that will be used to communicate with a WebMasterONE controller.
- Use the dialup networking adapter to connect the PC to the WebMasterONE.
- Open Internet Explorer.
- Type in the address 199.199.199.3. The sign-on screen for the WebMasterONE will come up.
- The sign-on screen of the WebMasterONE will come up. Type the User Name and Password (Access Code) in the text boxes and click the Submit button. The default user name is "webmaster" and the default passwords are "2001" for full access, "2002" for calibration only, and "2003" for read only. These defaults can and should be changed in the Access Code page.

4.6.5 Direct Ethernet (for a WebMasterONE not connected to a LAN)

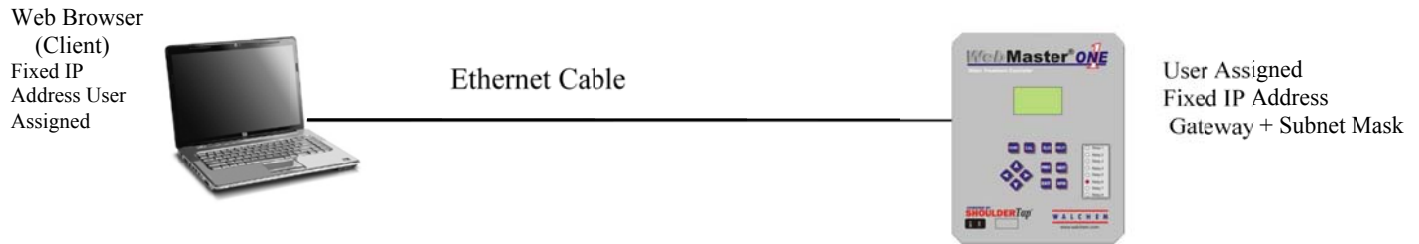

Equipment Required

- An Internet-ready computer.
- An Ethernet cable connection between the PC and WebMasterONE.
 - *Note: Ethernet cross-over cable is required if your PC is using Windows XP. For Vista, Windows 7 or Mac OS, a standard Ethernet cable will work.*

Setting up your computer:

- Go to LAN connections
 - For Windows XP: Control Panel > Network and Internet Connections > Network Connections > Local Area Network
 - For Windows Vista: Control Panel > Network and Sharing Center > Manage Network Connections
 - For Windows 7: Control Panel > View Network Status and Tasks
 - For Mac OSX: System Preferences > Ethernet
- Right-click on the LAN connection, and choose Properties.
- For Windows XP: Highlight **Internet Protocol (TCP-IP)**
- For Vista and Windows 7: Highlight **Internet Protocol Version 4 (TCP/IPv4)**
- For Mac OSX: Set **Configure IPv4** to Manually
- Select *Use the following IP address*
- Change the IP address to 10.0.100.30. Subnet mask should be 255.255.254.0.

Parameters that need to be programmed into the WebMasterONE

- The default settings will work with the LAN settings shown above. The default IP address for the controller is 10.0.100.29. The default subnet mask is 255.255.254.0.

Steps Required to Establish a Connection

- Open Internet Explorer.
- Type in the Ethernet IP address that has been assigned to the WebMasterONE (10.0.100.29).
- The sign-on screen of the WebMasterONE will come up. Type the User Name and Password (Access Code) in the text boxes and click the Submit button. The default user name is "webmaster" and the default passwords are "2001" for full access, "2002" for calibration only, and "2003" for read only. These defaults can and should be changed in the Access Code page.

4.6.6 Networking WebMasterONE Controllers via Ethernet

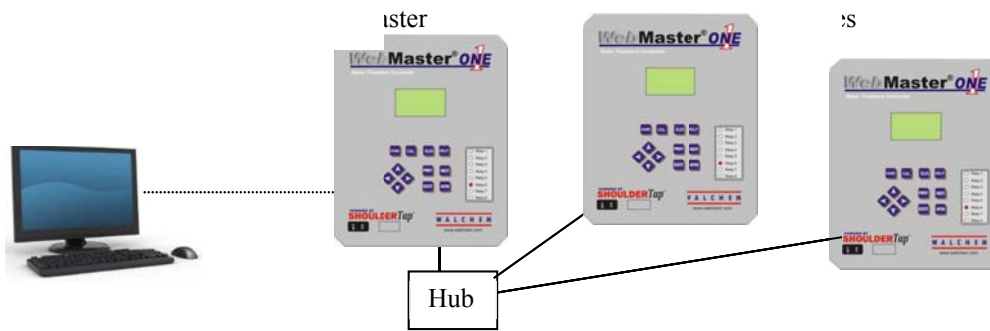

Equipment Required

- An Internet-ready computer.
- An Ethernet cable connection between each WebMasterONE using a hub or connection to LAN.

Utilities you need to set up on your computer

- There are no special drivers, adapters or other software components required on the PC to support networking. Refer to the previous sections for connecting to the master controller via USB, Ethernet, or modem.

Parameters that need to be programmed into the WebMasterONE

- Prior to attempting an Ethernet connection, the following information needs to be entered into the Communication page of each WebMasterONE on the network, either via an USB connection or via the local keypad.
- The Ethernet IP address of the WebMasterONE.
- The Subnet Mask.
- The Gateway IP address.
- The master must be selected as the master, and the slaves selected as slaves.

Steps Required to Establish a Connection

- Connect to the master controller using one of the methods described in sections 4.6.1 through 4.6.5.
- The sign-on screen of the WebMasterONE will come up. Type the User Name and Password (Access Code) in the text boxes and click the Submit button. The default user name is "webmaster" and the default passwords are "2001" for full access, "2002" for calibration only, and "2003" for read only. These defaults can and should be changed in the Access Code page.
- Once connected to the master, you may connect to the slaves by clicking on the link under the heading of "Sub-Network".
- You must log onto each slave using its user name and password.

4.7 Startup

Once the controller has been set up for your application, start up is a simple process. Check your supply of chemicals, turn on the controller power, calibrate all sensors as necessary, supply the sensors with a flow of sample water, and it will start controlling.

4.8 Shut Down

To shut down the controller, simply turn off the power. All set points will be retained in memory.

It is important that the optional pH and ORP electrodes remain wet. If it is possible for these electrodes to dry out, remove them from the flow assembly and place them in a cup or back in their original soaker bottles containing either pH 4 buffer solution or cooling tower water. Take care to avoid freezing temperatures when storing the electrodes to avoid breakage of the glass.

5.0 OPERATION – Using Local Display and Keypad



On power-up, the WebMasterONE display will show the process values from the sensors, and the most important alarm message. If there is more than one alarm, then pressing the Down Arrow key will display the additional alarm messages.

Pressing the Enter key will display the Main Menu. The menu selections are:

- Input Summary
- Indices
- Output Summary
- Alarms
- Calibration
- Relay Control (HOA)
- Set Points
- Communication
- Access Codes
- Software Upgrade
- Copy to USB Disk
- Feature Activations
- Controller Restart

Use the Next key to move the cursor down the list, or the Prev key to move the cursor up the list. Once the cursor is on the desired menu, press the Enter key to enter that menu.

5.1 Input Summary

The Input Summary menu displays the readings from all of the sensors, as well as any optional digital inputs, and analog inputs. Use the Next key to scroll down the list, or the Prev key to scroll up the list. There are no programmable parameters in this menu. No access code is required to enter this menu.

Press the Exit key to return to the Main Menu.

5.2 Indices

The Indices menu displays the calculated values of the Ryznar's Stability Index (RSI), Langliers Saturation Index (LSI), Use the Next key to scroll down the list, or Prev key to scroll up the list.

Below the displayed values are menus to change the wet test data used to calculate the various Indices: Calcium Hardness, and Total Alkalinity. Use the Next key to scroll down the list. When the cursor is next to the value that needs to be changed, use the Left and Right Arrow keys to move the cursor to the appropriate digit, then use the Up and Down Arrow keys to change the value of the digit.

Keep in mind that the cursor can move to blank spaces to the left of the numbers and change the blank to a number. Decimal points and minus signs may also be entered.

5.3 Output Summary

The Output Summary menu displays the state of the relays and the mA output of the optional 4-20 mA output cards. An access code will be required to enter this menu. Use the Arrow keys to enter the access code, then press the Enter key to continue. Use the Next key to scroll down the list, or the Prev key to scroll up the list. An Output Timeout may be reset from this menu by pressing the Enter key while the output that is in timeout is highlighted.

Press the Exit key to return to the Main Menu.

5.4 Alarms

The Alarms menu displays all alarm messages. Use the Next key to scroll down the list, or the Prev key to scroll up the list. There are no programmable parameters in this menu. No access code is required to enter this menu.

Press the Exit key to return to the Main Menu.

5.5 Calibration

The Calibration menu is used to calibrate the sensor inputs, as well as any optional 4-20 mA inputs. The list of options displayed will depend upon what options are installed in your WebMasterONE. Not all of the menus described below will necessarily appear on your display. An access code will be required to enter this menu. Use the Arrow keys to enter the access code, then press the Enter key to continue.

The possible inputs to calibrate include the following. Which parameters are available depends on which sensor type has been selected as being used:

- Sensor 1 – 4 (Sensor Cal and Temperature if applicable)
- 4-20 mA Input #1 through #8 (only if the optional 4-20 mA input card is installed)
- Each input will be listed using its Custom Name and Input Number

The possible calibration choices will be displayed. Use the Next key to move the cursor down the list, or the Prev key to move the cursor up the list. Once the cursor is on the desired menu, press the Enter key to start the calibration procedure.

Conductivity Calibration – Standard Contacting Electrode

“1 pt Process Cal – Calibrate” will be displayed. Press the Enter key to start the calibration. The reading from the system conductivity sensor will be displayed. Measure the conductivity of the system water using a hand held conductivity meter, and use the Arrow keys to enter the actual value. Press the Enter key to highlight ‘CONTINUE’, then press Enter again to put the new value into memory.

If the calibration correction factor is within +/- 50% of the uncalibrated conductivity, the display will say “Cal Successful”. Press the Enter key to resume control of the conductivity.

If the calibration factor is outside of +/- 50% of the uncalibrated conductivity, the display will say “New value out of limits, Cal Fail”. The most likely cause of this is a dirty sensor. Refer to Section 7 for cleaning instructions. If cleaning fails to cure the problem, refer to Section 8 for troubleshooting help.

Conductivity Calibration – Electrodeless Sensor

“1 pt Process Cal” and “Air Cal (Zero) will be displayed.

Use the Next key to move the cursor to the word “Calibrate” under the desired calibration routine. Press the Enter key to start the calibration procedure.

Air Cal (Zero)

The Air Calibration is necessary on initial start up, or when installing a new sensor, in order to set the sensor to read zero conductivity in air. This step must be done prior to the process calibration.

Place the Sensor in Air. Remove the sensor from the water and make sure that it is dry, especially in the holes. Wait for **several minutes** while the conductivity reading stabilizes. Press the Enter key to continue. If the value is within the range of calibration, it will display “Cal Successful”. Press the Enter key after replacing the sensor in the water.

If not, it will display “New value out of limits, Cal Fail”. Refer to Section 8 for troubleshooting.

1 pt Process Cal

The reading from the system conductivity sensor will be displayed. Measure the conductivity of the system water using a hand held conductivity meter, and use the Arrow keys to enter the actual value. Press the Enter key to highlight ‘CONTINUE’, then press Enter again to put the new value into memory.

If the calibration correction factor is within +/- 50% of the uncalibrated conductivity, the display will say “Cal Successful”. Press the Enter key to resume control of the conductivity.

If the calibration factor is outside of +/- 50% of the uncalibrated conductivity, the display will say “New value out of limits, Cal Fail”. The most likely cause of this is a dirty sensor. Refer to Section 7 for cleaning instructions. If cleaning fails to cure the problem, refer to Section 8 for troubleshooting help.

Temperature Calibration

The current temperature reading will be displayed. Measure the actual temperature of the system water and use the Arrow keys to enter this value. Press the Enter key to highlight 'CONTINUE', then press Enter again to put the new value into memory.

If the calibration factor is within +/- 15 degrees C (27 degrees F) the display will be "Cal Successful", otherwise it will be "Cal Fail".

pH Calibration

There are three calibration options that will be displayed. Use the Next key to move the cursor to the word "Calibrate" beneath the option that you want to use, then press the Enter key to start the calibration.

Most commonly used is the "2 pt Buffer Cal" where two pH standard solutions are used to calibrate the electrode. This is the most accurate, since the slope of the electrode (mV output per pH unit) is measured directly.

The "1pt Buffer Cal" is not as accurate, since it assumes that the slope of the electrode is 59 mV/pH unit, which will only be true with a new electrode. This can be OK if the pH never varies far from the value of the standard solution used in the calibration.

The third is a "1 pt Process Cal", where the pH electrode is left in the process solution, and the pH value is entered to match that of a hand held pH meter, or litmus paper. It also assumes a perfect slope.

2 pt Buffer Cal

Step 1 will explain that control is suspended during the calibration procedure. Press the Enter key when the cursor is on "Continue" to start the calibration. To cancel the calibration, press the Next key to move the cursor to "Cancel", then press the Enter key.

Step 2 will ask you to enter the temperature of the buffer solutions. Use the Arrow keys to change the value of the temperature, then press the Enter key to highlight 'CONTINUE', then press Enter again to put the value into memory.

Step 3 will prompt you to rinse the electrode, and place it into the first buffer solution. Press the Enter key to continue.

Step 4 will ask you to enter the value of the first buffer solution. Use the Arrow keys to change the value, then press the Enter key to highlight 'CONTINUE', then press Enter again to put the value into memory.

Step 5 will display the mV output of the electrode in the first buffer. When this reading is stable, press the Enter key to continue.

Step 6 will prompt you to rinse the electrode and place it in the second buffer. Press the Enter key to continue.

Step 7 will ask you to enter the value of the second buffer. Use the Arrow keys to change the value, then press the Enter key to highlight 'CONTINUE', then press Enter again to put the value into memory.

Step 8 will display the mV output of the pH electrode in the second buffer. When the reading is stable, press the Enter key to continue.

At the end of the calibration, the display will tell you if the calibration was successful or if the calibration failed. If successful, press the Enter key after the electrode has been replaced into the sample stream to resume control. If failed, refer to Section 8 for troubleshooting help. The calculated slope being more than 80% different from theoretical causes a calibration failure, or by the pH 7 mV offset being more than 60 mV.

1 pt Buffer Cal

Step 1 will explain that control is suspended during the calibration procedure. Press the Enter key when the cursor is on “Continue” to start the calibration. To cancel the calibration, press the Next key to move the cursor to “Cancel”, then press the Enter key.

Step 2 will ask you to enter the temperature of the buffer solution. Use the Arrow keys to change the value of the temperature, then press the Enter key to continue.

Step 3 will prompt you to rinse the electrode, and place it into the buffer solution. Press the Enter key to continue.

Step 4 will ask you to enter the value of the buffer solution. Use the Arrow keys to change the value, then press the Enter key to continue.

Step 5 will display the mV output of the electrode in the buffer. When this reading is stable, press the Enter key to continue.

At the end of the calibration, the display will tell you if the calibration was successful or if the calibration failed. If successful, press the Enter key after the electrode has been replaced into the sample stream to resume control. If failed, refer to Section 8 for troubleshooting help. The calculated slope being more than 80% different from theoretical causes a calibration failure, or by the pH 7 mV offset being more than 60 mV.

1 pt Process Cal

Step 1 will display the current pH reading of the system water. Below that, use the Arrow keys to fill in the new value, then press the Enter key to continue.

At the end of the calibration, the display will tell you if the calibration was successful or if the calibration failed. If successful, press the Enter key after the electrode has been replaced into the sample stream to resume control. If failed, refer to Section 8 for troubleshooting help. The calculated slope being more than 80% different from theoretical causes a calibration failure, or by the pH 7 mV offset being more than 60 mV.

ORP Calibration

2 pt Buffer Cal

Step 1 will explain that control is suspended during the calibration procedure. Press the Enter key when the cursor is on “Continue” to start the calibration. To cancel the calibration, press the Next key to move the cursor to “Cancel”, then press the Enter key.

Step 2 will prompt you to rinse the electrode, and place it into the first buffer solution. Press the Enter key to continue.

Step 3 will ask you to enter the value of the first buffer solution. Use the Arrow keys to change the value, then press the Enter key to highlight ‘CONTINUE’, then press Enter again to put the value into memory.

Step 4 will display the mV output of the electrode in the first buffer. When this reading is stable, press the Enter key to continue.

Step 5 will prompt you to rinse the electrode and place it in the second buffer. Press the Enter key to continue.

Step 6 will ask you to enter the value of the second buffer. Use the Arrow keys to change the value, then press the Enter key to highlight 'CONTINUE', then press Enter again to put the value into memory.

Step 7 will display the mV output of the pH electrode in the second buffer. When the reading is stable, press the Enter key to continue.

At the end of the calibration, the display will tell you if the calibration was successful or if the calibration failed. If successful, press the Enter key after the electrode has been replaced into the sample stream to resume control. If failed, refer to Section 8 for troubleshooting help. A calibration will fail if the offset calculated is more than 200 mV, or if the slope calculated is outside of 0.5-1.5.

1 pt Buffer Cal

Step 1 will explain that control is suspended during the calibration procedure. Press the Enter key when the cursor is on "Continue" to start the calibration. To cancel the calibration, press the Next key to move the cursor to "Cancel", then press the Enter key.

Step 2 will prompt you to rinse the electrode, and place it into the buffer solution. Press the Enter key to continue.

Step 3 will ask you to enter the value of the buffer solution. Use the Arrow keys to change the value, then press the Enter key to highlight 'CONTINUE', then press Enter again to put the value into memory.

Step 4 will display the mV output of the electrode in the buffer. When this reading is stable, press the Enter key to continue.

At the end of the calibration, the display will tell you if the calibration was successful or if the calibration failed. If successful, press the Enter key after the electrode has been replaced into the sample stream to resume control. If failed, refer to Section 8 for troubleshooting help. A calibration will fail if the offset calculated is more than 200 mV, or if the slope calculated is outside of 0.5-1.5.

1 pt Process Cal

Step 1 will display the current pH reading of the system water. Below that, use the Arrow keys to fill in the new value, then press the Enter key to highlight 'CONTINUE', then press Enter again to put the value into memory.

At the end of the calibration, the display will tell you if the calibration was successful or if the calibration failed. If successful, press the Enter key after the electrode has been replaced into the sample stream to resume control. If failed, refer to Section 8 for troubleshooting help. A failed calibration is caused by an offset from the uncalibrated reading of more than 200 mV.

Chlorine or Chlorine Dioxide Calibration

1 pt Process Cal

Ensure that the sensor is conditioned and equilibrated to the temperature of the sample.
Ensure that the sample flow rate is between 30 and 100 liters/hour.
Perform a test on the sample water for the oxidizer concentration.
Enter the 1 point process calibration menu.

Step 1 will display the current ppm reading of the water. When the reading is stable, use the Arrow keys to fill in the new value, then press the Enter key to highlight 'CONTINUE', then press Enter again to put the value into memory.

At the end of the calibration, the display will tell you if the calibration was successful or if the calibration failed. If successful, press the Enter key after the sensor has been replaced into the sample stream to resume control. If failed, refer to Section 8 for troubleshooting help.

Zero Cal

A zero calibration must be performed on initial installation, or after cleaning or replacing the membrane or electrolyte. This step must be done prior to the process calibration.

Remove the sensor from the flow cell and place it in a beaker of clean, oxidizer-free water.
Allow the sensor 15 minutes to equilibrate to the water temperature.
Enter the Zero Cal menu.

Step 1 will display the current mV reading from the sensor.
Stir the water with the sensor until the mV reading is stable for at least 5 minutes.
When the reading is stable, press Enter to continue.

If the value is within the range of calibration, it will display "Cal Successful". Press the Enter key after replacing the sensor in the flow cell.

If not, it will display "Calibration Failed!" Refer to Section 8 for troubleshooting.

4-20 mA Input 1-8 Calibration

Calibrate 4 mA

Following the instructions for your 4-20 mA transmitter, supply the WebMasterONE controller with a 4 mA signal from the transmitter. You should verify that the transmitter is accurate by measuring the output with an ammeter. You can read the present value of the mA signal as measured by the controller on the top line of the display. If the value is not exactly 4 mA, press the Enter key when the cursor is on "Calibrate 4 mA". Once this is done, the controller will read the transmitter signal as exactly 4 mA.

The transmitter signal must be +/- 2 mA of the expected 4 mA value, or else the calibration will fail.

Calibrate 20 mA

Repeat this process, supplying the controller with a 20 mA signal from the transmitter, and press the Enter key when the cursor is on the "Calibrate 20 mA" to make the present value exactly 20 mA.

The transmitter signal must be +/- 2 mA of the expected 20 mA value, or else the calibration will fail.

Calibrate 1 Pt (if not in Fluorometer Mode)

The 1-Point Calibration allows you to adjust the current reading of the process value to match what the actual value is as measured by some independent method (such as a laboratory measurement or handheld instrument). The software will maintain the “4 mA =” setting used to scale the input, and adjust the “20 mA =” setting to make the reading accurate at the value entered in the 1-Point Calibration.

Current mA

Displays a live reading of the mA output of the transmitter.

Current

Displays the live calculated process value, using the existing 4 mA = , 20 mA = and Units settings.

New

Use the arrow keys to enter the desired new reading for the process value. Use the Arrow keys to fill in the new value, then press the Enter key to highlight ‘CONTINUE’, then press Enter again to put the value into memory.

At the end of the calibration, the display will tell you if the calibration was successful or if the calibration failed. If successful, press the Enter key after the sensor has been replaced into the sample stream to resume control. If failed, refer to Section 8 for troubleshooting help.

Calibrate 1 Pt (Fluorometer Mode)

The 1-Point Calibration allows you to adjust the current reading of the process value to match what the actual value is as measured by some independent method (such as a laboratory measurement or handheld instrument). The software will maintain the “4 mA =” setting used to scale the input, and adjust the “20 mA =” setting to make the reading accurate at the value entered in the 1-Point Calibration.

Current mA

Displays a live reading of the mA output of the transmitter.

Prod Level

Displays the live calculated process value, using the existing 4 mA = , 20 mA = and Dye/Prod settings.

New

Use the arrow keys to enter the desired new reading for the dye concentration in ppb. Use the Arrow keys to fill in the new value, and then press the Enter key to tab to the next menu.

Dye/Prod

The Dye-to-Product ratio is the ratio of the fluorescent dye in ppb to the active ingredient in the chemical product in ppm. Use the Arrow keys to fill in the ratio (given to you by your chemical supplier). Press the Enter key to highlight ‘CONTINUE’, and then press Enter again to put the value into memory.

At the end of the calibration, the display will tell you if the calibration was successful or if the calibration failed. If successful, press the Enter key to resume control. If failed, refer to Section 8 for troubleshooting help.

Reset Cal

Reset Cal is used to reset the 4 mA and 20 mA calibration coefficients to the factory defaults. Press the Enter key and the factory calibration will be restored.

5.6 Relay Control (HOA)

This menu will present you with a list of each relay. To the right of the name of the relay will be an indication of the current state of the relay (OFF, or ON). To the right of this, the display will show either the time that the relay has been on, counting up (if the relay is responding to set point, and the time for the relay to shut off is unknown) or the time that has left to be on, counting down (if the relay has been activated by a timer, and the controller knows when it will shut off). Below the name of the relay will be the words “HAND” “OFF” and “AUTO”, each with a radio button to the left of the word. Use the Next key to move the cursor to the line containing the radio buttons. Use the Left Arrow and Right Arrow keys to move the cursor to the desired relay mode. Press the Enter key to change the mode of the relay.

If the relay is in the AUTO mode, then it will respond to the set points or other programmed parameters. This is the normal mode for the relay to be in.

If the relay is in the OFF mode, then the relay will be open regardless of whether the programming of the controller dictates that the relay should be ON or OFF. IF THE POWER TO THE CONTROLLER IS CYCLED OFF AND BACK ON, THE RELAY WILL REVERT BACK TO AUTO MODE.

If the relay is in the HAND mode, then the relay will be closed regardless of whether the programming of the controller dictates that the relay should be ON or OFF. If a Hand Time Limit has been programmed in the controller, the relay will shut off after this time has elapsed, and the mode will revert back to AUTO.

5.7 Set Points

This menu is used to adjust any of the control set points for the relays that are simple entries of numbers. Any configuration of feed control modes (for example, bleed and feed versus feed based on makeup volume) or biocide cycles (for example, changing from daily to weekly adds), etc. may NOT be changed using the keypad. These types of changes require a computer to accomplish. Refer to Section 6 for detailed descriptions of each control mode and set point menu.

Pressing the Enter key with Set Points highlighted will bring you to this display:

SET POINTS

Relay 1 (R1) Set Points
Relay 2 (R2) Set Points
Relay 3 (R3) Set Points
Relay 4 (R4) Set Points
Relay 5 (R5) Set Points
Relay 6 (R6) Set Points
Relay 7 (R7) Set Points
Relay 8 (R8) Set Points

If the relay has been given a custom name, this name will precede the relay number. Pressing Next moves the highlight down the list, while Prev moves the opposite direction. Press Enter to go into the highlighted menu. Press Exit to return to the Main Menu.

Relay 1- 8 Set Points

The set points available for each relay will vary depending upon the control mode selected. A computer connection is required to change the control mode. The units of measure of some of the set points will vary depending upon sensor input that may be assigned to the relay.

Set Point xxxxx (if control mode is any on/off set point, time proportional, target PPM)

Use the arrow keys to change the process value at which you want the relay to activate. The set point value is limited to the range of the sensor input. Press Enter to accept the changes.

Dead Band xxxxx (if control mode is on/off set point)

Use the arrow keys to change the process value away from the set point at which the relay will deactivate. For example, if you are forcing the conductivity lower, your set point is 2000 $\mu\text{S}/\text{cm}$, and your dead band is 100 $\mu\text{S}/\text{cm}$, then the relay will activate at 2001 and deactivate at 1900 $\mu\text{S}/\text{cm}$. The purpose of the dead band is to prevent rapid cycling of the relay open and closed, which can shorten its life. The dead band should be set for the lowest value that still prevents the relay from chattering. Press Enter to accept the new value.

Sample Period (minutes) xxxx (if control mode is time proportional feed)

Use the arrow keys to adjust the number of minutes used for the time proportional control sample period. Any value between 1 and 1440 is acceptable. Press Enter to accept the new value.

Proportional Band xxxx (if control mode is time proportional feed)

Use the arrow keys to adjust the distance from the set point where the maximum output activation time will occur. This parameter will be in the units of measure of the sensor input used to control the relay. The acceptable range for this set point varies with the input. Press Enter to accept the new value.

Duration (if control mode is intermittent sampling)

Use the arrow keys to set the minutes and press Enter to accept the new value. Then press Next to move the cursor to the seconds and adjust with the arrow keys and press Enter to accept. Any value between 10 sec and 60 minutes is acceptable. The duration is the time that the valve will be open in order to get a fresh water sample to the electrode.

Hold Time (if control mode is intermittent sampling)

Use the arrow keys to set the minutes and press Enter to accept the new value. Then press Next to move the cursor to the seconds and adjust with the arrow keys and press Enter to accept. Any value between 10 sec and 10 minutes is acceptable. The hold time is the time that the valve will be closed following a sample, but prior to the conductivity measurement. The hold time should ensure that the sample is water and not steam.

Blowdown Time (if control mode is intermittent sampling)

Use the arrow keys to set the fixed blowdown time (in minutes) and press Enter to accept the new value. Any value between 1 and 1440 minutes is acceptable. If the conductivity exceeds the set point, the blowdown valve will activate for this time.

Interval Time (if control mode is intermittent sampling)

Use the arrow keys to set the time between samples (in minutes) and press Enter to accept the new value. Any value between 5 and 1440 minutes is acceptable.

Prop Band (if control mode is intermittent sampling, proportional blowdown)

Use the arrow keys to adjust the distance from the set point where the maximum output activation time will occur. This parameter will be in the units of measure of the sensor input used to control the relay. The acceptable range for this set point varies with the input. Press Enter to accept the new value.

Fixed Time to Feed (if control mode is feed with another relay, feed after another relay (fixed))

Use the arrow keys to set the minutes and press Enter to accept the new value. Then press Next to move the cursor to the seconds and adjust with the arrow keys and press Enter to accept. Any value between 1 sec and 1440 minutes is acceptable.

% of Relay to Feed (if control mode is feed after another relay (%))

Use the arrow keys to change the % of the time that the lead relay runs that this relay should run and press Enter to accept the change. Any value between 0 and 100% is acceptable.

Time Period (if control mode is feed as % of time)

Use the arrow keys to change the length of the time cycle to be used, then press Enter to accept the changes. Any value between 1 and 1440 minutes is acceptable.

% of Period to Feed (if control mode is feed as % of time)

Use the arrow keys to change the percentage of the time period that will be used to activate the relay, then press Enter to accept the changes. Any value between 0 and 100% is acceptable.

Spike Point (if control mode is any spike set point)

Use the arrow keys to change the higher set point then press Enter to accept the changes. The set point value is limited to the range of the sensor input.

Unit Vol to Trigger xxxxx (if control mode is flow-based feed or target PPM)

Use the arrow keys to change the volume of solution that needs to flow through the flow meter in order to trigger the chemical feed. Any value between 1 and 10,000 is acceptable. Press Enter to accept the new value.

Output On-Time (min) xxxx (sec) xx (if control mode is flow-based or counter-based feed)

Use the arrow keys to change the amount of time for the relay to be activated, once the previously specified volume of solution has passed through the flow meter, or counts have been detected by the digital input. First change the minutes using the arrow keys, then Press Enter. Any value between 1 and 1440 minutes is acceptable. Press Next to move to the seconds, and use the arrow keys to adjust the seconds. Press Enter to accept the new value.

Counts Before Trigger xxxxx (if control mode is counter-based feed)

Use the arrow keys to change the number of counts on the digital input that will trigger the relay to activate. Any value between 0 and 99,999 is acceptable. Press the Enter key to accept the new value.

Output On Time (if control mode is Dispersant)

Use the arrow keys to change the pump on time (in minutes) then press Enter to accept the changes. Any value between 1 and 1440 is acceptable.

Output On Time Setup (if control mode is biocide timer or spike set point based feed)

This menu is used to change the amount of time that the output will activate for each programmed event. Again, it is not possible to reschedule events using the keypad. Press Enter with Output On Time highlighted to access the screens that show each event:

RLYL-8 TIMER ADDS	
Event	A . . . T
Time Of Day	xx:xx
Output On Time	
	(min)xxxxx (sec)xx
NEXT	for next event
PREV	f. previous evnt

Use the arrow keys to change the relay on time in minutes. Any value between 1 and 1440 is acceptable. Press Enter to accept the new value. Press Next to move to the seconds, use the arrow keys to adjust the seconds, and Press Enter to accept the new value. Press Next to advance to the next programmed event, or Prev for the previous scheduled event. Prev will also move you from sec to min within an event.

On Delay (if control mode is Activate on a DI)

Use the arrow keys to change the time (in minutes:seconds) to delay the relay activation once the DI changes to the active state, then press Enter to accept the changes. Any value between 1 and 1440 is acceptable.

Off Delay (if control mode is Activate on a DI)

Use the arrow keys to change the time (in minutes:seconds) to delay the relay deactivation once the DI changes to the non-active state, then press Enter to accept the changes. Any value between 1 and 1440 is acceptable.

Specific Gravity (if control mode is target PPM)

Use the arrow keys to change the specific gravity of the chemical product being fed. Any value between 0 and 10 g/ml is acceptable.

Pump Rating (if control mode is target PPM)

Use the arrow keys to change the flow rate of the metering pump feeding the chemical product. Any value between 0 and 1000 gal or liters per hour is acceptable.

Output Time Limit xxxx

Use the arrow keys to change the maximum amount of time that the relay can be continuously activated before the controller deactivates the relay and activates a Output Time Limit alarm. Press the Enter key to accept the new value. The Output Time Limit is intended to prevent runaway control on a faulty sensor input.

Note that the relay will not activate again until someone resets the timer!

It will take some experience to find out what the normal output on-time will be. If the relay cycles open and closed under worst case conditions in 30 minutes, you may want to set the Output Time Limit at 60 minutes.

Hand Time Limit xxxx

Use the arrow keys to change the maximum number of minutes that the Bleed output can be activated in the Hand mode. Any value between 0 and 1440 is acceptable. A value of 0 means the output can be left on indefinitely. Press Enter to accept the new value.

5.8 Communication

This menu is used to enter the information required to communicate with the WebMasterONE using the modem option via the Internet, or using the Ethernet option. Once this information is entered, a remote PC may be used to configuring all or the set points that are unavailable with the keypad.

For Internet communications, it is also possible to do a manual test of the WebMasterONE's ability to use its modem to dial a local Internet Service Provider (ISP) and connect to the Internet.

The display will show a list of the various parameters. Use the Next key to move the cursor to the line below the parameter. Use the Up and Down Arrow keys to change each character to the correct number, letter, or symbol. Use the Left and Right Arrow keys to move the cursor to the next character. Press Enter once all characters have been changed to the desired values.

Dial-up ISP Username (only if modem is installed)

When the controller needs to dial out and connect to the Internet Service Provider, it needs to identify itself with a user name, so that the ISP knows that it has an account. Enter the user name here.

Dial-up ISP Password (only if modem is installed)

Similarly, the controller needs to identify itself with a password in order to connect with the ISP. Enter the password here.

Dial-up ISP Local Phone (only if modem is installed)

Enter the phone number for the controllers Internet Service Provider. This will be the phone number that it attempts to dial when getting on the Internet.

Controller Phone # (only if modem is installed)

When you need to communicate with the controller, you go to the web site, link to the WebMasterONE access page, and a call is made from our server to the controller to wake it up. Enter the phone number for the controller, exactly as it needs to be dialed by our server in the USA. If the WebMasterONE is installed within the USA or Canada, this may include the 1 prefix. If the WebMasterONE is installed in another country, it must include the 011 prefix, country code, and phone number.

When the cursor is on the pull down menu for the country code, use the UP or DOWN arrow keys to scroll through the list of countries. The correct prefix (1 or 011) will be selected automatically. Then press Next to move the cursor to the phone number and use the Arrow keys to change the number. Press Enter to accept the changes.

Dial ISP (only if modem is installed)

This menu is used to manually dial the WebMasterONE's ISP. Press the Enter key when the cursor is on this to start the process.

A new screen will appear. The first line will show the **Dial up Status**. This menu is informational only, and tells you what is happening with the dialup connection. Possible status messages include:

<u>Message</u>	<u>Explanation</u>
Off Line	The controller is not connected.
Dialing xxx-xxxx	The controller is dialing out to the ISP.
No Dial Tone	The controller can not dial out due to phone line or modem problems.
No phone number	There is nothing entered in the ISP Phone No. field.
Connecting to ISP	The controller is successfully negotiating a connection with the ISP.
On Line	The controller is now on the Internet.
Checking for Upgrade	The controller is communicating with our server to see if a software upgrade is available.
Connection Timeout in xxxxx sec	The Internet connection process is complete. The number of seconds displayed depends upon the value entered in the Dialup Connection Lifetime text box described below.

The second line is the **Dial up Dynamic IP** Address. This is informational, and tells you the last IP assigned to the WebMasterONE by its ISP the last time it connected. When the manual ISP Dial up process is successful, this number should change.

The third line is the date and time of the last successful connection with the ISP.

The bottom line will display "Dial ISP", "Log Off" and "Cancel".

Pressing the Enter key while the cursor is on "**Dial ISP**" will make another attempt to dial the ISP. Pressing the Enter key while the cursor is on "**Log Off**" will disconnect the WebMasterONE from the ISP. It is VERY IMPORTANT that you log off, or the controller will keep the connection on the Internet until the connection times out. It is possible that this programmable maximum connection time could be set for infinity, which could be expensive!

Pressing the Enter key while the cursor is on "**Cancel**" will stop the WebMasterONE from attempting the Dial up process.

Ethernet IP Address

When a controller is attached to a network, your IT Administrator needs to assign it an Ethernet IP address. When you want to communicate with the controller from your PC on the network, you go to your Browser and type in the controller's address.

Ethernet Subnet Mask

When a controller is attached to a network, your IT Administrator must also assign the IP Subnet Mask. Enter this number here.

Ethernet Gateway

When a controller is attached to a network, your IT Administrator must also assign the Gateway. Enter this number here.

5.9 Access Codes

There are three levels of access code protection. If the *Master* password is used in the WebMasterONE, then any set point can be changed. If the *Calibration Level* password is used, then sensor calibrations will be allowed, but other changes will not. If the *Read Only* password is used the user will be able to look at any menu, but will not be allowed to make any changes.

In order to change the access code for each level of access, use the Next key to move the cursor to the space next to Present, and use the Arrow keys to make the characters match the present access code (you have to know the present code to change it). Press the Enter key to move the cursor next to New, then use the Arrow keys to make the characters match your new access code and press Enter.

The default user name is "webmaster" and the default passwords are "2001" for full access, "2002" for calibration only, and "2003" for read only. These defaults can and should be changed to assure security.

5.10 Software Upgrade



CAUTION! There are live circuits inside the controller even when the power switch on the front panel is in the OFF position! The front panel must never be opened before power to the controller is REMOVED!

The software of the controller may be easily updated in the field, adding new features or fixing any bugs. This can be accomplished in a few quick steps:

- a. Save the new software upgrade to a 32 MB (or higher) USB flash memory stick. These are available from the factory, or may be found locally.
- b. Plug the memory stick into one of the USB Host connections on the core interface board (see Figure 3). The stick will only fit in one direction.
- c. Enter the Software Upgrade Menu. Press Next until the word START is highlighted, then press Enter.
- d. The Status section of the screen will indicate that the upgrade has started. Once it finishes (in a few minutes) the controller will reboot.
- e. Remove the memory stick. This may be used to upgrade as many controllers as you would like.

5.11 Copy to USB Disk



CAUTION! There are live circuits inside the controller even when the power switch on the front panel is in the OFF position! The front panel must never be opened before power to the controller is REMOVED!

The data log file may be manually downloaded to a USB disk. Press Enter to initiate the process:

1. Plug a USB memory stick into one of the USB host connections. The file size may be as large as 2 MB.
2. Press Enter when 'Copy User Log' is highlighted to start downloading.
3. When the Copy Status becomes 'File Copied', you may press Exit to return to the Main Menu and remove the USB disk.

5.12 Feature Activations

This menu is used to activate all of the various communications software features in the field. If you have purchased the controller with the communication feature, it will already be activated and no further action will be necessary. Press Enter to view a list of any activated features.

To activate a software feature in the field, purchase the activation key file from your distributor and save it on the root drive of a USB flash drive. Disconnect power to the controller, and insert the flash drive into the USB Host connector on the front panel (see figure 3). Close the front panel and restore power. Enter the Feature Activation menu. “New Activation” will be highlighted. Press Enter to open the New Activation menu. “Start” will be highlighted. Press Enter to start the activation process. The Status screen will display the progress and in a few seconds will show if the process was successful or not.

As many as three activation types are possible: Modbus TCP, Sub-Networking, and one of several communications options. If more than one feature needs to be activated, this process must be repeated for each one.

5.13 Controller Restart

This menu is used to safely restart the controller. This should be used instead of cycling power in order to shut down the program in the proper manner.

6.0 OPERATION – Using PC



These units control continuously as long as power is applied. This section describes how to set up the controller utilizing a PC. See Section 5.0 for instructions utilizing the controller keypad and display.

When you first access the controller, the System Summary page will be displayed in the main frame of the browser, and the Name of the controller and Alarm Status will be displayed in the top frame. Links to each main menu page are located along the left side of the screen.

The menus are organized by inputs and outputs. Each input has menus for calibration, selecting units of measure, etc. as required. Each output has menus for defining the set points, maximum on-time, method of control, etc.

Keep in mind when the controller is powered, it will be responding to default set points. As set points are changed, the controller will start using the new set points immediately. If it is undesirable for the controller to activate valves and pumps during the set up process, either disconnect them, or go to the “Hand-Off-Auto” menu for each output and force them “Off”.

6.1 Menu Selection Links

Along the left side of your PC monitor will be links to the various menu pages.

The exact configuration of your WebMasterONE Series controller will determine which menus are available to you. Some menus only appear if an optional circuit board is installed. Others only appear if a certain option is selected in the Start Up menu. Below is a list of all possible Menu selections, and when they will appear.

Menus that appear all the time:

Start up	Level	Remote Alarming
System Summary	Flow meter	System Auto Report
“Custom Name” Sensor 1	Generic	Datalog Auto Report
“Custom Name” Relay 1	Interlock	Manual Datalog
“Custom Name” Relay 2	Level Switch	Graphing/Trending
“Custom Name” Relay 3	Feed Verification	Communications
“Custom Name” Relay 4	Generic Input	Configuration File
“Custom Name” Relay 5	Counter	Notepad
“Custom Name” Relay 6	4-20 mA Input	Access Codes
“Custom Name” Relay 7	Digital Inputs	Help
“Custom Name” Relay 8		

Menu that appears only if one or more sensor input boards are installed:

“Custom Name” Sensor 2
“Custom Name” Sensor 3
“Custom Name” Sensor 4

Menu that appears only if a software upgrade is available:

Software upgrade

Menu that appears only if one or more 4-20mA output boards are installed:

“Custom Name” Analog Output 1
“Custom Name” Analog Output 2
“Custom Name” Analog Output 3
“Custom Name” Analog Output 4

Menu that appears only when selected from the Startup Page:

LSI/RSI

6.2 Start up Menu

Select the option that you want for each of the sections on the page. When you click on the “Submit” button at the bottom of the page, your changes will take effect. If you move to another page without clicking “Submit” first, your changes will be lost!

Controller Name

Type the name that you want to use to identify the controller, up to 32 characters, in the text box. For example, “XYZ Corp, North Tower”

Controller Time and Date

Update the date and time by clicking the arrow on the pull-down list and selecting the correct values.

Controller Date Format

Click on the radio button that corresponds to the desired date format. The choices are Month/Day/Year, Day/Month/Year or Year/Month/Day.

Sensors 1-4

Use the pull-downs to select which type of sensor is connected to that input. If the input option cards are not installed for Sensors 2-4, then the pull-down will not be available. The sensor options are Not Used, Contacting Conductivity, Electrodeless Conductivity, pH, ORP, Chlorine, Chlorine Dioxide and High Temp Conductivity.

Make sure that you correctly match the programmed sensor type with the actual sensor type connected to that input!

Digital Inputs

Use the pull-downs to select the function for each of the digital inputs. Digital Inputs A-F are standard, while Digital Inputs 1-6 are only available if the Digital Input option card has been installed. The functions available are explained below.

Make sure that you correctly match the programmed sensor type with the actual sensor type connected to that input!

Not Used should be selected if nothing is connected to that input.

Contacting Flow Meter should be selected if a low frequency (10 Hz maximum) contacting-head water meter is connected to that input. These are generally reed switch sensors that give one dry contact closure every gallon or more of volume through the meter. A sensor of this type must be connected to Digital Input A-F or 1-4.

Paddlewheel Flow Meter should be selected if a high frequency (10 – 300 Hz) Hall Effect style flow meter is connected to the input. The input is not compatible with flow sensors that generate their own sine wave. A sensor of this type must be connected to Digital Input A-D or 5-6.

Counter should be selected if the contact closure from the sensor will be used to log counts and/or to initiate a relay to activate for a given time after a given number of counts. A sensor of this type can be connected to any Digital Input.

Interlock should be selected if the contact closure will be used to deactivate relays that are normally being controlled by some other means. A sensor of this type can be connected to any Digital Input.

Level Switch should be selected if the device connected is a liquid level switch. This is normally used to send an alarm if the liquid level gets too high or low. A sensor of this type can be connected to any Digital Input.

Feed Verification should be selected if a metering pump feed verification device is connected to the input. These devices can count strokes of the pump's diaphragm, totalize the flow, and send an alarm if the WebMasterONE relay used to activate the pump is active, but the device is not registering any flow. A sensor of this type can be connected to any Digital Input.

Generic Input should be selected if the contact closure will be used to log the current state of the contact (open or closed). A custom message can be assigned to each state. An alarm may be sent if the contact changes state, if desired. A sensor of this type can be connected to any Digital Input.

4-20 mA Inputs 1 - 8

This section will only appear if there is an analog input card installed in the controller.

Use the pull-downs to select the function of the analog input channel. The functions available are described below.

Make sure that you correctly match the programmed sensor type with the actual sensor type connected to that input!

Not Used should be selected if nothing will be connected to the input channel.

Level should be selected if a liquid level transmitter will be connected to the input channel. The input can be logged, or alarms sent if the level is outside programmed values.

Flow Meter should be selected if a flow transmitter is connected to the input channel. The controller can log the flow rate, total flow volume, and alarm if the flow rate or total is outside programmed values. Relays can also be controlled to activate for a given time after a given volume of solution has passed through the flow meter.

Generic should be selected if the transmitter connected to the input is anything else but the types described above. You will be able to span the input, give it a custom name and units of measure, set alarm points, and use it to control relays.

Relay (1 – 8) Control Mode

Use the pull-downs to select the control mode for each relay. The various choices are described below. **Once the control modes have been selected, click the Submit Changes button.** This will change the Relay Input Assignment section that comes next, making the possible choices for the input assignment match the control mode.

Not Used should be selected if the relay is not being used.

On/Off Set Point should be selected if the relay needs to respond to a sensor input or analog input signal. The relay will activate and deactivate if the input value goes outside of programmed limits. In the relay menu, you will specify the set point value, dead band value, control direction, etc.

Time Proportional should be selected if the relay will be activated for a larger percentage of a programmable time period as the process value gets further away from the set point value.

Cycles of Concentration should be selected to activate the relay based on a set point that is the ratio of two conductivity sensor input readings. This option is only available if at least two sensors are defined as conductivity sensors.

Intermittent (Fixed Blowdown Time) should be selected for boiler control where the conductivity is checked at a fixed time interval, and if found to be above the set point, the relay is activated for a fixed time.

Intermittent (Proportional Blowdown Time) should be selected for boiler control where the conductivity is checked at a fixed time interval, and if found to be above the set point, the relay is activated for a time that varies with the conductivity's deviation from the set point.

Flow based Feed should be selected if the relay will be triggered to activate for a programmable amount of time after a given volume of water has passed by the flow meter. In the relay menu, the volume to trigger feed, and the amount of time of the feed will be specified.

Feed With Another Relay should be selected if you want to activate this relay at the same time as another relay (for example, inhibitor feed and bleed).

Feed After Another Relay (%) should be selected if you want to activate this relay after another relay has finished its activation cycle (for example, inhibitor feed after bleed). This relay will activate for a percentage of the time that the other relay was active.

Feed After Another Relay (Fixed Time) should be selected if you want to activate this relay after another relay has finished its activation cycle (for example, inhibitor feed after bleed). This relay will activate for a programmable amount of time.

Feed as % Time should be selected to activate the relay for a given percentage of a user-specified time period.

Spike Set Point 1 Week Cycle should be selected to activate the relay based on one set point for a majority of the time, and then spiking the concentration for a programmable amount of time, as often as once per day, on a weekly schedule. This is typically an oxidizer addition based on an ORP electrode.

Spike Set Point 2 Week Cycle should be selected to activate the relay based on one set point for a majority of the time, and then spiking the concentration for a programmable amount of time, as often as once per day, on a bi-weekly schedule. This is typically an oxidizer addition based on an ORP electrode.

Spike Set Point 4 Week Cycle should be selected to activate the relay based on one set point for a majority of the time, and then spiking the concentration for a programmable amount of time, as often as once per day, on a monthly schedule. This is typically an oxidizer addition based on an ORP electrode.

Daily Biocide Timer should be selected if the relay will be activated up to 10 times per day, every day, at a programmed time of day, for a programmed amount of time. In the relay menu, you will specify the time of day for the relay to activate, as well as the amount of time it will be activated.

1 Week Biocide Timer should be selected if the relay will be activated on a schedule that is the same every week. In the relay menu, you will specify the day of the week and the time of day for the relay to activate, as well as the duration of the activation. The relay can activate only once per day.

2 Week Biocide Timer is identical to the weekly timer, except the schedule will repeat in a two-week cycle.

4 Week Biocide Timer is identical to the weekly timer, except the schedule will repeat every four weeks.

Dispersant should be selected to activate the relay for a fixed time either before or after a biocide addition.

Bleed Volume based on Makeup Volume should be selected if the relay will be triggered to activate by a volume of makeup water, and will be deactivated by a volume of bleed. Note that flow meters must be installed on both the bleed and the makeup lines to use this mode.

Alarm should be selected if the relay is to be activated based on an alarm condition.

Activate on a DI should be selected if the relay is to be activated whenever a digital input is in either an open or a closed state.

Target PPM Feed should be selected if the relay is to be activated to feed a chemical to achieve a PPM set point. This algorithm triggers the relay activation when a user-defined volume of makeup water (measured by up to 3 water meters) is added to the system. The relay on-time is calculated using the PPM set point, cycles of concentration (measured or calculated), specific gravity of the chemical product, and programmed pump flow rate.

Target PPM Feed with Feed Verification should be selected if the relay is to be activated to feed a chemical to achieve a PPM set point. This algorithm triggers the relay activation when a user-defined volume of makeup water (measured by up to 3 water meters) is added to the system. The relay on-time is calculated using the PPM set point, cycles of concentration (measured or calculated), specific gravity of the chemical product, programmed pump volume per stroke, and number of strokes counted by a feed verification device.

Click on the “Submit Changes” button to save the changes. This will change the Relay Input Assignment section that comes next, making the possible choices for the input assignment match the control mode.

Analog Output Control Mode (1 – 4)

This section will only appear if there are one or more 4-20 mA output cards installed.

Use the pull-downs to select the control mode for each analog output: Not Used or Retransmit.

Relay (1 – 8) Input Assignment

This section is where the input used to control the relay is assigned. The choices available in the pull-down will depend upon the control mode of the relay. If you have changed the control mode of any relay, click the Submit Changes button before selecting the input assignment.

If the relay control mode is Not Used:
The relay input assignment is Not Applicable.

If the relay control mode is On/Off Set Point, or Time Proportional:
The relay input assignment choices will be any of the sensor inputs, and any of the optional analog inputs. Any number of relays may be assigned to the same input.

If the relay control mode is Cycles of Concentration:
The relay input assignment choices will be any of the conductivity inputs. Any number of relays may be assigned to the same input.

If the relay control mode is Intermittent (Fixed Blowdown Time), Intermittent (Proportional Blowdown Time):
The relay input assignment choices will be any of the sensor or analog inputs. Any number of relays may be assigned to the same input.

If the relay control mode is Flow Based Feed, Bleed Vol on Makeup Vol, Target PPM Feed or Target PPM Feed with Feed Verification:

The relay input assignment choices will be any digital or optional analog inputs that are defined as a flow meter input.

If the relay control mode is any of the Biocide Timer Based Feed options:
The relay input assignment is Not Applicable.

If the relay control mode is Feed with Another Relay, Feed After Another Relay (%) or Feed After Another Relay (Fixed Time):
The relay input assignment choices will be all the other relays.

If the relay control mode is Feed as % Time or Dispersant:
The relay input assignment is Not Applicable.

If the relay control mode is any of the Spike modes:
The relay input assignment choices will be all sensors and analog inputs.

If the relay control mode is Alarm:
The relay input assignment is Not Applicable.

If the relay control mode is Activate on a DI:
The relay input assignment will be any Interlock or Generic Input digital inputs.

Analog Output Input Assignment (1 – 4)

This section will only appear if there are one or more 4-20 mA output cards installed.

Use the pull-downs to select the input signal that will be retransmitted as a 4-20 mA output signal. The possible choices include any sensor input, any sensor temperature signal, or any 4-20 mA input signal (only applicable if the analog input card is installed).

LCD Display Setup

Up to five parameters may be presented on the front panel LCD display. Click on the radio buttons next to the parameters to show.

6.3 System Summary Menu

There are no programmable parameters in the System Summary Menu page. Several tables will be displayed, with information on sensor readings, analog input readings, digital input states, alarms, relay state, etc.

6.4 Sensor Menu - Conductivity Input

Select the option or type in the values that you want for each of the sections on the page. When you click on the “Submit” button at the bottom of the page, your changes will take effect. If you move to another page without clicking “Submit” first, your changes will be lost!

Certain menu sections will only be visible if you have selected certain options in the start up menu.

Type of Sensor

Click the pull-down to select the type of sensor that you have installed. The rest of this section assumes that you have selected contacting conductivity or electrodeless conductivity.



Warning! The power to the WebMasterONE must be cycled off and back on before the sensor type change is completely implemented! The detection of the actual type of sensor installed occurs at power up.

Custom Name

You can rename the input by typing a custom name in the text box provided. This name will appear as the link to the input page, on the System Summary report, as a choice for relay input assignments, on data logs, and in alarm messages.

Conductivity Range (only appears if the Type of Sensor is Electrodeless Conductivity)

Click on the radio button to select the conductivity range that matches your electrodeless conductivity sensor (and also the process to be measured!). The choices are 0 –1000 $\mu\text{S}/\text{cm}$, 0-10,000 $\mu\text{S}/\text{cm}$, 0-100 mS/cm , or 0-1,000 mS/cm .

You must have the correct sensor to match the conductivity range!

Conductivity Units

Click on the radio button to select the units of measure that you want to use. You will have to click the “Submit” button at the bottom of the page to see more menus that relate to ppm or % concentration if you change units of measure.

Backup Sensor Mode

The redundant sensor algorithm will allow the user to define a primary sensor to use for control and a backup sensor. If the primary sensor goes invalid, the backup sensor will automatically take over control, and the sensor error alarm will activate. If the sensors don't match each other within user-defined limits but both are valid readings, control will stop and a Sensor Deviated alarm will activate. If the backup sensor goes invalid while the primary sensor is OK, control continues but the sensor error alarm will activate. If both sensors are invalid, control stops and the sensor error alarms activate.

To select this sensor as the backup sensor, click the Enable radio button, then click on the Submit button at the bottom of the page. The page will reload showing the status of the sensor as Backup, and offer additional menus:

Primary Sensor Assignment

This menu only appears if the Redundant Sensor Setting is Backup.

Use the pulldown arrow to select the sensor to use as the primary control sensor. All sensors of the same type as the backup sensor will appear in the pulldown list.

Deviation from Primary Sensor

This menu only appears if the Redundant Sensor Setting is Backup.

Type the maximum allowable difference between the two sensor readings. If this deviation is exceeded, then control of any outputs using the sensor will stop and an alarm activated.

Current Reading/Perform Calibration

The *current reading* is a live reading of the calibrated conductivity of the sample.

To *Calibrate* the conductivity, click on the “Perform Calibration” button and a new window will open in your browser. You will have two options, a one-point process calibration or an air (zero) calibration.

Always set the *air calibration* first. This should only need to be done once for any given sensor. Click the Calibrate button. Make sure that the sensor is in the air and dry, then click the Continue button. The controller will either accept the calibration or will reject it if the voltage reading is too far from the expected for a zero reading. Click the Close button to return to the Conductivity Input page.

For the *one-point process calibration*, click its Calibrate button. It will display the current conductivity reading. Determine the actual conductivity of the solution by measuring it with a calibrated conductivity instrument, and type this value in the text box, then click the Continue button. The controller will either accept the calibration or will reject it if the conductivity entered is too far from the factory calibration reading. The limit is $\pm 50\%$ of the uncalibrated reading. Click the Close button to return to the Conductivity Input page.

Status

This section is for information only, and lets you know if any alarm conditions exist. Possible status messages are; Normal (everything is OK), Sensor Error (the sensor signal is not valid), High Alarm, Low Alarm or Calibration Time. For Sensors 2, 3 and 4 an error message for Circuit Board Failure is also possible. See section 8.1 for a complete description of error messages.

Date of Last Calibration

This section is for information only, and lets you know when the last calibration occurred.

Calibration Reminder

If you want to be reminded when the sensor needs calibration, for example every 30 days then type the desired number of days between calibration in the text box. A value of zero means you will never be reminded. The highest value allowed is 365 days.

Self Test

The Self Test is used to check the circuitry of the conductivity input. Click on the “Self Test” button, and the controller will display either Pass or Fail, and also readings of a simulated conductivity and temperature. If the controller passes self test, and you are having problems reading the correct conductivity, then the problem must be with the sensor, wiring or installation.

ppm Conversion Factor (only appears if ppm selected as the unit of measure)

Type the value that you want to use to convert $\mu\text{S}/\text{cm}$ to ppm into the text box. The range allowed is 0.5 to 1.0 ppm per $\mu\text{S}/\text{cm}$.

Uncalibrated Conductivity

This section is for information only, and shows the conductivity reading without any calibration. This is helpful in troubleshooting the conductivity sensor. During a one-point calibration, the new value must be within $\pm 50\%$ of this reading or else the calibration will be rejected.

High-High Alarm Limit

Type in the text box the sensor process value above which you want a high-high alarm to occur.

High Alarm Limit

Type in the text box the sensor process value above which you want a high alarm to occur.

Low Alarm Limit

Type in the text box the sensor process value below which you want a low alarm to occur.

Low-Low Alarm Limit

Type in the text box the sensor process value below which you want a low-low alarm to occur.

Alarm Dead Band

Type in the text box the dead band to be used for each alarm set point.

Damping

Damping is applied to the sensor input by taking a running average of the readings of the input signal over the time frame specified by the damping setting (0-60 seconds). The averaged reading is displayed and used for control. Type in the text box the desired time frame.

Temperature

Note: The temperature sensor detection is checked when the WebMasterONE is powered up. Make sure that the sensor connections are made prior to turning on the power.

Current Temperature

Displays a live reading of the temperature of the system water. If no temperature sensor is detected at power-up, this will be “Manual Temperature” and allow the temperature to be typed into the text box.

Status

Possible status messages are; Normal (everything is OK), Sensor Error (the signal is not valid), High Alarm, or Low Alarm. See section 8.1 for a complete description of error messages.

Calibrate

Click on the “Calibrate” button and a new window will open that read “To Modify the Current Value”, and displays the current reading and a text box in which to type the actual value. Measure the temperature of the sample with a thermometer, and type the actual value into the text box. Click the Submit button. The new value will be displayed. Click the Close button to close the calibrate window.

This menu will not appear if no temperature sensor is detected at power-up.

Temperature Units

Click on the radio button to select units of measure of either Fahrenheit or Celsius.

Uncalibrated Temperature

Displays the temperature reading before correcting with calibration constants. This is helpful for troubleshooting.

This menu will not appear if no temperature sensor is detected at power-up.

High Alarm

In the text box, type the maximum temperature that you would reasonably expect to see for the sample. This is helpful to detect a faulty or poorly calibrated temperature sensor.

This menu will not appear if no temperature sensor is detected at power-up.

Low Alarm

In the text box, type the minimum temperature that you would reasonably expect to see for the sample. This is helpful to detect a faulty or poorly calibrated temperature sensor.

This menu will not appear if no temperature sensor is detected at power-up.

Click on the “Submit” button to save the changes.

6.5 Sensor Menu - pH Input

Select the option or type in the values that you want for each of the sections on the page. When you click on the “Submit” button at the bottom of the page, your changes will take effect. If you move to another page without clicking “Submit” first, your changes will be lost!

Certain menu sections will only be visible if you have selected certain options in the start up menu.

Type of Sensor

Click the pull-down to select the type of sensor that you have installed. The rest of this section assumes that you have selected pH.

Custom Name

You can rename the input by typing a custom name in the text box provided. This name will appear as the link to the input page, on the System Summary report, as a choice for relay input assignments, on data logs, and in alarm messages.

Backup Sensor Mode

The redundant sensor algorithm will allow the user to define a primary sensor to use for control and a backup sensor. If the primary sensor goes invalid, the backup sensor will automatically take over control, and the sensor error alarm will activate. If the sensors don't match each other within user-defined limits but both are valid readings, control will stop and a Sensor Deviated alarm will activate. If the backup sensor goes invalid while the primary sensor is OK, control continues but the sensor error alarm will activate. If both sensors are invalid, control stops and the sensor error alarms activate.

To select this sensor as the backup sensor, click the Enable radio button, then click on the Submit button at the bottom of the page. The page will reload showing the status of the sensor as Backup, and offer additional menus:

Primary Sensor Assignment

This menu only appears if the Redundant Sensor Setting is Backup.

Use the pulldown arrow to select the sensor to use as the primary control sensor. All sensors of the same type as the backup sensor will appear in the pulldown list.

Deviation from Primary Sensor

This menu only appears if the Redundant Sensor Setting is Backup.

Type the maximum allowable difference between the two sensor readings. If this deviation is exceeded, then control of any outputs using the sensor will stop and an alarm activated.

Current Reading/Perform Calibration

The *current reading* is a live reading of the calibrated pH of the sample.

To *Calibrate* the pH electrode click on the “Perform Calibration” button and a new window will appear. Select a *2-point calibration*, a *1-point calibration* or a *1-point process calibration* by clicking the appropriate button.

2 Point Calibration

First you will see a warning that pH control will be suspended during the calibration. Click on “Continue” to start the calibration, or “Cancel” to abort the calibration.

If no temperature element is detected, then the controller will allow you to enter the buffer temperature manually. Otherwise it will display the electrode temperature.

You then be prompted to “Please Rinse the Electrode”. Do so, and then click “Continue”.

You will now be prompted to type in the value of the first buffer being used. Do so, and then click “Continue”.

You will now see the mV output from the electrode. When this value is stable, click “Continue”.

You then be prompted to “Please Rinse the Electrode”. Do so, and then click “Continue”.

You will now be prompted to type in the value of the second buffer being used. Do so, and then click “Continue”.

You will now see the mV output from the electrode. When this value is stable, click “Continue”.

The WebMasterONE will either pass or fail the calibration, and prompt you to return the electrode to the process. Click “Continue” when you are ready for pH control to resume.

If the calibration fails for any reason, refer to Section 8 for troubleshooting help.

1 Point Calibration

First you will see a warning that pH control will be suspended during the calibration. Click on “Continue” to start the calibration, or “Cancel” to abort the calibration.

If no temperature element is detected, then the controller will allow you to enter the buffer temperature manually. Otherwise it will display the electrode temperature.

You then be prompted to “Please Rinse the Electrode”. Do so, and then click “Continue”.

You will now be prompted to type in the value of the buffer being used. Do so, and then click “Continue”.

You will now see the mV output from the electrode. When this value is stable, click “Continue”.

The WebMasterONE will either pass or fail the calibration, and prompt you to return the electrode to the process. Click “Continue” when you are ready for pH control to resume.

If the calibration fails for any reason, refer to Section 8 for troubleshooting help.

1 Point Process Calibration

The new window will display the current value of the pH, using the last calibration. Measure the pH of a sample of the water using a handheld meter, and type the new pH value in the text box. Click the “Continue” button.

The WebMasterONE will either pass or fail the calibration. Control of the pH will continue throughout this process.

If the calibration fails for any reason, refer to Section 8 for troubleshooting help.

Status

Possible status messages are; Normal (everything is OK), Sensor Error (the signal is not valid), High Alarm, Low Alarm, Circuit Board Failure (for Sensors 2, 3 or 4) or Calibration Time. See section 8.1 for a complete description of error messages.

Date of Last Calibration

This section is for information only, and lets you know when the last calibration occurred.

Calibration Reminder

If you want to be reminded when the sensor needs calibration, for example every 30 days then type the desired number of days between calibration in the text box. A value of zero means you will never be reminded. The highest value allowed is 365 days.

Self Test

The Self Test is used to check the circuitry of the pH input. Click on the “Self Test” button, and the controller will display either Pass or Fail, and also readings of a simulated pH and temperature. If the controller passes self test, and you are having problems reading the correct pH or calibrating, then the problem must be with the electrode, wiring or installation.

Uncalibrated mV

Displays the mV signal from the pH electrode in the current sample. This is useful for troubleshooting.

Calculated Slope

This displays the slope (change in the mV output of the pH electrode per pH unit) of the pH electrode as of the last calibration. A perfect electrode will change by approximately 59 mV per pH unit. This is helpful for troubleshooting, and also to predict when the electrode may need to be replaced.

Calculated Offset

This displays the mV output of the pH electrode in pH 7 as of the last calibration. A perfect electrode will generate 0 mV at pH 7. The offset information is also helpful for troubleshooting.

% Difference from theoretical

This displays the % difference of the slope from the theoretical value as of the last calibration. The higher this percentage, the weaker the pH electrode. The calibration will fail if this percentage exceeds 80%. This number is the most useful to determine how much life is left in the electrode.

High-High Alarm Limit

Type in the text box the sensor process value above which you want a high-high alarm to occur.

High Alarm Limit

Type in the text box the sensor process value above which you want a high alarm to occur.

Low Alarm Limit

Type in the text box the sensor process value below which you want a low alarm to occur.

Low-Low Alarm Limit

Type in the text box the sensor process value below which you want a low-low alarm to occur.

Alarm Dead Band

Type in the text box the dead band to be used for each alarm set point.

Damping

Damping is applied to the sensor input by taking a running average of the readings of the input signal over the time frame specified by the damping setting (0-60 seconds). The averaged reading is displayed and used for control. Type in the text box the desired time frame.

Temperature

Note: The temperature sensor detection is checked when the WebMasterONE is powered up. Make sure that the sensor connections are made prior to turning on the power.

Current Temperature

Displays a live reading of the temperature of the system water. If no temperature sensor is detected at power-up, this will be “Manual Temperature” and allow the temperature to be typed into the text box.

Status

Possible status messages are; Normal (everything is OK), Sensor Error (the signal is not valid), High Alarm, or Low Alarm. See section 8.1 for a complete description of error messages.

Calibrate

Click on the “Calibrate” button and a new window will open that read “To Modify the Current Value”, and displays the current reading and a text box in which to type the actual value. Measure the temperature of the sample with a thermometer, and type the actual value into the text box.

Click the Submit button. The new value will be displayed. Click the Close button to close the calibrate window.

This menu will not appear if no temperature sensor is detected at power-up.

Temperature Units

Click on the radio button to select units of measure of either Fahrenheit or Celsius.

Uncalibrated Temperature

Displays the temperature reading before correcting with calibration constants. This is helpful for troubleshooting.

This menu will not appear if no temperature sensor is detected at power-up.

High Alarm

In the text box, type the maximum temperature that you would reasonably expect to see for the sample. This is helpful to detect a faulty or poorly calibrated temperature sensor.

This menu will not appear if no temperature sensor is detected at power-up.

Low Alarm

In the text box, type the minimum temperature that you would reasonably expect to see for the sample. This is helpful to detect a faulty or poorly calibrated temperature sensor.

This menu will not appear if no temperature sensor is detected at power-up.

Click on the “Submit” button to save the changes.

6.6 Sensor Menu - ORP Input

Select the option or type in the values that you want for each of the sections on the page. When you click on the “Submit” button at the bottom of the page, your changes will take effect. If you move to another page without clicking “Submit” first, your changes will be lost!

Certain menu sections will only be visible if you have selected certain options in the start up menu.

Type of Sensor

Click the pull-down to select the type of sensor that you have installed. The rest of this section assumes that you have selected ORP.

Custom Name

You can rename the input by typing a custom name in the text box provided. This name will appear as the link to the input page, on the System Summary report, as a choice for relay input assignments, on data logs, and in alarm messages.

Backup Sensor Mode

The redundant sensor algorithm will allow the user to define a primary sensor to use for control and a backup sensor. If the primary sensor goes invalid, the backup sensor will automatically take over control, and the sensor error alarm will activate. If the sensors don't match each other within user-defined limits but both are valid readings, control will stop and a Sensor Deviated alarm will activate. If the backup sensor goes invalid while the primary sensor is OK, control continues but

the sensor error alarm will activate. If both sensors are invalid, control stops and the sensor error alarms activate.

To select this sensor as the backup sensor, click the Enable radio button, then click on the Submit button at the bottom of the page. The page will reload showing the status of the sensor as Backup, and offer additional menus:

Primary Sensor Assignment

This menu only appears if the Redundant Sensor Setting is Backup.

Use the pulldown arrow to select the sensor to use as the primary control sensor. All sensors of the same type as the backup sensor will appear in the pulldown list.

Deviation from Primary Sensor

This menu only appears if the Redundant Sensor Setting is Backup.

Type the maximum allowable difference between the two sensor readings. If this deviation is exceeded, then control of any outputs using the sensor will stop and an alarm activated.

Current Reading/Calibrate

The *current reading* is a live reading of the calibrated ORP of the sample.

To *Calibrate* the ORP electrode click on the “Perform Calibration” button and a new window will appear. Select a *2-point calibration*, a *1-point calibration* or a *1-point process calibration* by clicking the appropriate button.

2 Point Calibration

First you will see a warning that ORP control will be suspended during the calibration. Click on “Continue” to start the calibration, or “Cancel” to abort the calibration.

You then be prompted to “Please Rinse the Electrode”. Do so, and then click “Continue”.

You will now be prompted to type in the value of the first standard solution being used. Do so, and then click “Continue”.

You will now see the mV output from the electrode. When this value is stable, click “Continue”.

You then be prompted to “Please Rinse the Electrode”. Do so, and then click “Continue”.

You will now be prompted to type in the value of the second buffer being used. Do so, then click “Continue”.

You will now see the mV output from the electrode. When this value is stable, click “Continue”.

The WebMasterONE will either pass or fail the calibration, and prompt you to return the electrode to the process. Click “Continue” when you are ready for ORP control to resume.

If the calibration fails for any reason, refer to Section 8 for troubleshooting help.

1 Point Calibration

First you will see a warning that ORP control will be suspended during the calibration. Click on “Continue” to start the calibration, or “Cancel” to abort the calibration.

You then be prompted to “Please Rinse the Electrode”. Do so, and then click “Continue”.

You will now be prompted to type in the value of the standard solution being used. Do so, and then click “Continue”.

You will now see the mV output from the electrode. When this value is stable, click “Continue”.

The WebMasterONE will either pass or fail the calibration, and prompt you to return the electrode to the process. Click “Continue” when you are ready for ORP control to resume.

If the calibration fails for any reason, refer to Section 8 for troubleshooting help.

1 Point Process Calibration

The new window will display the current value of the ORP, using the last calibration. Measure the ORP of a sample of the water using a handheld meter, and type the new ORP value in the text box. Click the “Continue” button.

The WebMasterONE will either pass or fail the calibration. Control of the ORP will continue throughout this process.

If the calibration fails for any reason, refer to Section 8 for troubleshooting help.

Status

Possible status messages are; Normal (everything is OK), Sensor Error (the signal is not valid), High Alarm, Low Alarm, Circuit Board Failure or Calibration Time. See section 8.1 for a complete description of error messages.

Date of Last Calibration

This section is for information only, and lets you know when the last calibration occurred.

Calibration Reminder

If you want to be reminded when the electrode needs calibration, for example every 30 days then type the desired number of days between calibration in the text box. A value of zero means you will never be reminded. The highest value allowed is 365 days.

Self Test

The Self Test is used to check the circuitry of the ORP input. Click on the “Self Test” button, and the controller will display either Pass or Fail, and also readings of a simulated ORP. If the controller passes self test, and you are having problems reading the correct ORP or calibrating, then the problem must be with the electrode, wiring or installation.

Uncalibrated Reading

Displays the mV signal from the ORP electrode in the current sample prior to calibration. This is useful for troubleshooting.

Calculated Slope

This displays the slope (change in the mV output of the ORP electrode per expected mV change) of the ORP electrode as of the last calibration. A perfect electrode will have a slope of 1.000. This is helpful for troubleshooting, and also to predict when the electrode may need to be replaced.

Calculated Offset

This displays the mV output of the ORP electrode at 0 mV as of the last calibration. The offset information is helpful for troubleshooting.

High-High Alarm Limit

Type in the text box the sensor process value above which you want a high-high alarm to occur.

High Alarm Limit

Type in the text box the sensor process value above which you want a high alarm to occur.

Low Alarm Limit

Type in the text box the sensor process value below which you want a low alarm to occur.

Low-Low Alarm Limit

Type in the text box the sensor process value below which you want a low-low alarm to occur.

Alarm Dead Band

Type in the text box the dead band to be used for each alarm set point.

Damping

Damping is applied to the sensor input by taking a running average of the readings of the input signal over the time frame specified by the damping setting (0-60 seconds). The averaged reading is displayed and used for control. Type in the text box the desired time frame.

6.7 Sensor Menu – Chlorine, Chlorine Dioxide Inputs

Select the option or type in the values that you want for each of the sections on the page. When you click on the “Submit” button at the bottom of the page, your changes will take effect. If you move to another page without clicking “Submit” first, your changes will be lost!

Certain menu sections will only be visible if you have selected certain options in the start up menu.

Type of Sensor

Click the pull-down to select the type of sensor that you have installed. The rest of this section assumes that you have selected Chlorine or Chlorine Dioxide.

Custom Name

You can rename the input by typing a custom name in the text box provided. This name will appear as the link to the input page, on the System Summary report, as a choice for relay input assignments, on data logs, and in alarm messages.

Backup Sensor Mode

The redundant sensor algorithm will allow the user to define a primary sensor to use for control and a backup sensor. If the primary sensor goes invalid, the backup sensor will automatically take over control, and the sensor error alarm will activate. If the sensors don't match each other within user-defined limits but both are valid readings, control will stop and a Sensor Deviated alarm will activate. If the backup sensor goes invalid while the primary sensor is OK, control continues but

the sensor error alarm will activate. If both sensors are invalid, control stops and the sensor error alarms activate.

To select this sensor as the backup sensor, click the Enable radio button, then click on the Submit button at the bottom of the page. The page will reload showing the status of the sensor as Backup, and offer additional menus:

Primary Sensor Assignment

This menu only appears if the Redundant Sensor Setting is Backup.

Use the pulldown arrow to select the sensor to use as the primary control sensor. All sensors of the same type as the backup sensor will appear in the pulldown list.

Deviation from Primary Sensor

This menu only appears if the Redundant Sensor Setting is Backup.

Type the maximum allowable difference between the two sensor readings. If this deviation is exceeded, then control of any outputs using the sensor will stop and an alarm activated.

Current Reading/Calibrate

The *current reading* is a live reading of the calibrated concentration of oxidizer in the sample. To *Calibrate* the sensor click on the “Perform Calibration” button and a new window will appear. Select a *zero calibration* or a *1-point process calibration* by clicking the appropriate button.

Zero Calibration

A zero calibration must be performed on initial installation, or after cleaning or replacing the membrane or electrolyte. This step must be done prior to the process calibration.

Remove the sensor from the flow cell and place it in a beaker of clean, oxidizer-free water.

Allow the sensor 15 minutes to equilibrate to the water temperature.

Click on the Zero Calibration button.

Step 1 will display the current mV reading from the sensor and direct you to place the sensor in pure water. Stir the water with the sensor until the mV reading is stable for at least 5 minutes.

Click Continue when the mV reading is stable.

If the value is within the range of calibration, it will display “Zero Calibration was Successful”. Press the Enter key after replacing the sensor in the flow cell.

If not, it will display “Calibration Failed!” Refer to Section 8 for troubleshooting.

1 Point Process Calibration

Ensure that the sensor is conditioned and equilibrated to the temperature of the sample.

Ensure that the sample flow rate is between 30 and 100 liters/hour.

Perform a test on the sample water for the oxidizer concentration.

Enter the 1 point process calibration menu.

Step 1 will display the current ppm reading of the water using the previous calibration. When the reading is stable, use the Arrow keys to fill in the new value, and then click on the Continue button.

At the end of the calibration, the display will tell you if the calibration was successful or if the calibration failed. If successful, press the Enter key after the sensor has been replaced into the sample stream to resume control. If failed, refer to Section 8 for troubleshooting help.

The WebMasterOne will either pass or fail the calibration. Control of the oxidizer will continue throughout this process.

If the calibration fails for any reason, refer to Section 8 for troubleshooting help.

Status

Possible status messages are; Normal (everything is OK), Sensor Error (the signal is not valid), High Alarm, Low Alarm, Circuit Board Failure or Calibration Time. See section 8.1 for a complete description of error messages.

Date of Last Calibration

This section is for information only, and lets you know when the last calibration occurred.

Calibration Reminder

If you want to be reminded when the electrode needs calibration, for example every 30 days then type the desired number of days between calibration in the text box. A value of zero means you will never be reminded. The highest value allowed is 365 days.

Self Test

The Self Test is used to check the circuitry of the sensor input. Click on the “Self Test” button, and the controller will display either Pass or Fail, and also readings of a simulated oxidizer sensor. If the controller passes self test, and you are having problems reading the correct value or calibrating, then the problem must be with the sensor, wiring or installation.

mV

Displays the mV signal from the sensor in the current sample prior to calibration or conversion into ppm. This is useful for troubleshooting.

Calculated Slope

This displays the slope (mV output of the sensor per ppm of oxidizer) of the sensor as of the last calibration. A perfect sensor will have a slope of 100 (except it's 1.00 mv/ppm for the PAA sensor). This is helpful for troubleshooting, and also to predict when the electrode may need to be replaced.

Calculated Offset

This displays the mV offset of the sensor at 0 ppm (0 mV) as of the last zero calibration. The offset information is helpful for troubleshooting.

High-High Alarm Limit

Type in the text box the sensor process value above which you a want a high-high alarm to occur.

High Alarm Limit

Type in the text box the sensor process value above which you a want a high alarm to occur.

Low Alarm Limit

Type in the text box the sensor process value below which you want a low alarm to occur.

Low-Low Alarm Limit

Type in the text box the sensor process value below which you want a low-low alarm to occur.

Alarm Dead Band

Type in the text box the dead band to be used for each alarm set point.

Damping

Damping is applied to the sensor input by taking a running average of the readings of the input signal over the time frame specified by the damping setting (0-60 seconds). The averaged reading is displayed and used for control. Type in the text box the desired time frame.

Temperature

Note: The temperature sensor detection is checked when the WebMasterOne is powered up. Make sure that the sensor connections are made prior to turning on the power. If no temperature sensor is detected at power-up, this menu will not appear.

For conductivity and pH sensors, the temperature signal or manually entered temperature is used for automatic temperature compensation of the sensor reading, data logging, and control. For other sensor types, the temperature signal may be logged or used to control an output, but it is not used to correct the sensor reading.

Current Temperature

Displays a live reading of the temperature of the system water.

Status

Possible status messages are; Normal (everything is OK), Sensor Error (the signal is not valid), High Alarm, or Low Alarm. See section 8.1 for a complete description of error messages.

Calibrate

Click on the “Calibrate” button and a new window will open that read “To Modify the Current Value”, and displays the current reading and a text box in which to type the actual value. Measure the temperature of the sample with a thermometer, and type the actual value into the text box. Click the Submit button. The new value will be displayed. Click the Close button to close the calibrate window.

Temperature Units

Click on the radio button to select units of measure of either Fahrenheit or Celsius.

Uncalibrated Temperature

Displays the temperature reading before correcting with calibration constants. This is helpful for troubleshooting.

High Alarm

In the text box, type the maximum temperature that you would reasonably expect to see for the sample. This is helpful to detect a faulty or poorly calibrated temperature sensor.

Low Alarm

In the text box, type the minimum temperature that you would reasonably expect to see for the sample. This is helpful to detect a faulty or poorly calibrated temperature sensor.

Click on the “Submit” button to save the changes.

6.8 Level (4-20 mA) Input Menu

(Only appears if a 4-20 mA input option card is installed, and a Level pull-down is selected in the 4-20 mA Input section of the Start Up page)

Input

Displays which 4-20 mA inputs are defined as level inputs.

Drum

Type in the text box the name of the container the level sensor to the left is measuring.

Volume

This displays the current volume of chemical remaining in that drum.

Raw mA

This displays the mA output of the level transmitter, before it is converted into a volume. This is helpful for troubleshooting.

Status

This displays whether the current drum level is “Normal” or in “Low Alarm”. Possible status messages for level transmitters are; Normal (everything is OK), Sensor Error (the sensor signal is not valid), Over Range (between 20 and 21 mA), Under Range (between 3.9 and 4.0 mA), Low Alarm or Circuit Board Failure.

Full Volume

Type into the text box the volume contained by a full drum.

mA when tank “empty”

Type into the text box the mA output that the level transmitter will send when the drum is empty.

mA when tank “full”

Type into the text box the mA output that the level transmitter will send when the drum is full.

High-High Alarm Limit

Type in the text box the process value above which you want a high-high alarm to occur.

High Alarm Limit

Type in the text box the process value above which you want a high alarm to occur.

Low Alarm Limit

Type in the text box the process value below which you want a low alarm to occur.

Low-Low Alarm Limit

Type in the text box the process value below which you want a low-low alarm to occur.

Alarm Dead Band

Type in the text box the dead band to be used for each alarm set point.

Damping

Damping is applied to the input by taking a running average of the readings of the input signal over the time frame specified by the damping setting (0-60 seconds). The averaged reading is displayed and used for control. Type in the text box the desired time frame.

Backup Sensor Mode

The redundant sensor algorithm will allow the user to define a primary sensor to use for control and a backup sensor. If the primary sensor goes invalid, the backup sensor will automatically take over control, and the sensor error alarm will activate. If the sensors don't match each other within user-defined limits but both are valid readings, control will stop and a Sensor Deviated alarm will activate. If the backup sensor goes invalid while the primary sensor is OK, control continues but the sensor error alarm will activate. If both sensors are invalid, control stops and the sensor error alarms activate.

To select this sensor as the backup sensor, click the Backup radio button, then click on the Submit button at the bottom of the page. The page will reload showing the status of the sensor as Backup, and offer additional menus:

Primary Sensor Assignment

This menu only appears if the Redundant Sensor Setting is Backup.

Use the pulldown arrow to select the sensor to use as the primary control sensor. All sensors of the same type as the backup sensor will appear in the pulldown list.

Deviation from Primary Sensor

This menu only appears if the Redundant Sensor Setting is Backup.

Type the maximum allowable difference between the two sensor readings. If this deviation is exceeded, then control of any outputs using the sensor will stop and an alarm activated.

6.9 Flow Meter (4-20 mA) Input Menu

(Only appears if a 4-20 mA input option card is installed, and a Flow Meter pull-down is selected in the 4-20 mA Input section of the Start Up page)

Backup Sensor Mode

The redundant sensor algorithm will allow the user to define a primary sensor to use for control and a backup sensor. If the primary sensor goes invalid, the backup sensor will automatically take over control, and the sensor error alarm will activate. If the sensors don't match each other within user-defined limits but both are valid readings, control will stop and a Sensor Deviated alarm will activate. If the backup sensor goes invalid while the primary sensor is OK, control continues but the sensor error alarm will activate. If both sensors are invalid, control stops and the sensor error alarms activate.

To select this sensor as the backup sensor, click the Backup radio button, then click on the Submit button at the bottom of the page. The page will reload showing the status of the sensor as Backup, and offer additional menus:

Primary Sensor Assignment

This menu only appears if the Redundant Sensor Setting is Backup.

Use the pulldown arrow to select the sensor to use as the primary control sensor. All sensors of the same type as the backup sensor will appear in the pulldown list.

Deviation from Primary Sensor

This menu only appears if the Redundant Sensor Setting is Backup.

Type the maximum allowable difference between the two sensor readings. If this deviation is exceeded, then control of any outputs using the sensor will stop and an alarm activated.

Input

This column displays all of the 4-20 mA inputs that are defined as Flow Meter type.

Custom Name

Type in the text box the customer name that you may want to give to this flow meter.

Rate

This column will display the flow rate through (or past) the flow meter.

Present mA

This column will display the mA output of the flow meter.

4 mA=

Type the flow rate at which the flow meter will send a 4 mA signal into the text box. This will generally be at 0 gallons or liters/minute.

Dead Band

The dead band prevents the flow total from accumulating when the flowmeter transmitter output is just slightly above 4 mA. For example, entering a dead band of 0.1 mA means that any transmitter signal below 4.1 mA will be recorded as a flow rate of 0.

20 mA =

Type the flow rate at which the water meter will send a 20 mA signal into the text box. This will generally be at the maximum rated flow rate of the meter.

Units

Type the units of measure for the flow rate into the text box.

Rate High-High Alarm Limit

Type in the text box the process value above which you want a high-high alarm to occur.

Rate High Alarm Limit

Type in the text box the process value above which you want a high alarm to occur.

Rate Low Alarm Limit

Type in the text box the process value below which you want a low alarm to occur.

Low-Low Alarm Limit

Type in the text box the process value below which you want a low-low alarm to occur.

Rate Alarm Dead Band

Type in the text box the dead band to be used for each alarm set point.

Damping

Damping is applied to the input by taking a running average of the readings of the input signal over the time frame specified by the damping setting (0-60 seconds). The averaged reading is displayed and used for control. Type in the text box the desired time frame.

6.10 Generic (4-20 mA) Input Menu

(only appears if a 4-20 mA option card is installed, and a Generic pull-down is selected in the 4-20 mA input section of the Start Up page)

Input

Displays which 4-20 mA inputs have been selected as “Generic” in the 4-20 mA input section of the Start Up page.

Name

Type in the text box a name to describe the device connected to that 4-20 mA input (for example “Pressure”).

Present Value

This displays the current reading of the device, using the mA signal from the device, the span of the 4-20 mA signal defined in “4 mA =” and “20 mA =” below, and the units of measure defined below.

Present mA

This displays the present raw mA signal from the device. This is helpful in troubleshooting.

Status

This displays whether the present value is “Normal”, or in a “Low Alarm” or “High Alarm” condition. Possible status messages are; Normal (everything is OK), Sensor Error (the sensor signal is not valid), Over Range (between 20 and 21 mA), Under Range (between 3.9 and 4.0 mA), High Alarm, Low alarm or Circuit Board Failure. See section 8.1 for a complete description of error messages.

4 mA =

Type into the text box the value that corresponds to a 4 mA output signal from the device. For example, if the pressure transmitter sends out 4 mA at 0.00 psi, type in 0.00. Any value between – 10,000 and 10,000 is acceptable.

20 mA =

Type into the text box the value that corresponds to a 20 mA output signal from the device. For example, if the pressure transmitter sends out 20 mA at 100 psi, type in 100. Any value between – 10,000 and 10,000 is acceptable.

Units

Type into the text box the units of measure that you want to use for the device connected to that input. For example, you could use “psi”, “Bars”, etc.

High-High Alarm Limit

Type in the text box the process value above which you want a high-high alarm to occur.

High Alarm Limit

Type in the text box the process value above which you want a high alarm to occur.

Low Alarm Limit

Type in the text box the process value below which you want a low alarm to occur.

Low-Low Alarm Limit

Type in the text box the process value below which you want a low-low alarm to occur.

Alarm Dead Band

Type in the text box the dead band to be used for each alarm set point.

Damping

Damping is applied to the input by taking a running average of the readings of the input signal over the time frame specified by the damping setting (0-60 seconds). The averaged reading is displayed and used for control. Type in the text box the desired time frame.

Fluorometer Mode

The Fluorometer Mode should be selected if a Turner Fluorometer is being used. This will change the 1-Point Calibration to make it easy to adjust the ppm reading of the chemical product based on measurement of the fluorescent dye.

To select this transmitter as fluorometer, click the Enable radio button, then click on the Submit button at the bottom of the page.

Backup Sensor Mode

The redundant sensor algorithm will allow the user to define a primary sensor to use for control and a backup sensor. If the primary sensor goes invalid, the backup sensor will automatically take over control, and the sensor error alarm will activate. If the sensors don't match each other within user-defined limits but both are valid readings, control will stop and a Sensor Deviated alarm will activate. If the backup sensor goes invalid while the primary sensor is OK, control continues but the sensor error alarm will activate. If both sensors are invalid, control stops and the sensor error alarms activate.

To select this sensor as the backup sensor, click the Backup radio button, then click on the Submit button at the bottom of the page. The page will reload showing the status of the sensor as Backup, and offer additional menus:

Primary Sensor Assignment

This menu only appears if the Redundant Sensor Setting is Backup.

Use the pulldown arrow to select the sensor to use as the primary control sensor. All sensors of the same type as the backup sensor will appear in the pulldown list.

Deviation from Primary Sensor

This menu only appears if the Redundant Sensor Setting is Backup.

Type the maximum allowable difference between the two sensor readings. If this deviation is exceeded, then control of any outputs using the sensor will stop and an alarm activated.

6.11 4-20 mA Input Menu

This page is used to assign the purpose of each 4-20 mA input and to calibrate each input.

Status

Possible status messages are Normal (everything is OK), Sensor Error (the sensor signal is not valid), Over Range (between 20 and 21 mA), Under Range (between 3.9 and 4.0 mA), High Alarm, Low Alarm or Circuit Board Failure. See section 8.1 for a complete description of error messages.

4-20 mA Input Assignment Menu

This table is used to reassign the function of the device connected to the input. Click on the pull-down that best describes what is connected to the input. If you assign the inputs on this page, you need to click on the Submit button to see the appropriate menu selections on the page. These are normally already defined in the Start up page.

Not Used should be selected if nothing is connected to that input.

Level should be selected if a *continuous* level transmitter is attached to that output. For *point* level devices, which do not use a 4-20 mA signal, wire into and program with the Digital Inputs section.

Flow Meter should be selected if an analog flow transmitter is connected to that input.

Generic should be selected if the 4-20 mA transmitter connected to that input is anything other than the previously mentioned ones. Later when you re-submit the 4-20 mA Input Page, you will be able to name the input (for example, Phosphate or System Pressure) and also define the Units of Measure (like mg/l or psi).

4-20 mA Input Calibration Menu

Set 4 mA

Following the instructions for your 4-20 mA transmitter, supply the WebMasterONE with a 4 mA signal from each transmitter. You should verify that the transmitter is accurate by measuring the output with an ammeter. You can read the present value of the mA signal as measured by the WebMasterONE in the second column of the table. If the present value is not exactly 4 mA, click on the “Set 4 mA” button. You will be asked to verify that you want to change the calibration. Once this is done, the controller will read the transmitter signal as exactly 4 mA.

Set 20 mA

Repeat this process, supplying the WebMasterONE with a 20 mA signal from each transmitter, and click on the “Set 20 mA” button in order to calibrate the controller.

1 Pt Cal (if not in Fluorometer Mode)

The 1-Point Calibration allows you to adjust the current reading of the process value to match what the actual value is as measured by some independent method (such as a laboratory measurement or handheld instrument). The software will maintain the “4 mA =” setting used to scale the input, and adjust the “20 mA =” setting to make the reading accurate at the value entered in the 1-Point Calibration. A new window will open when you click the 1 Pt Cal button.

Current mA

Displays a live reading of the mA output of the transmitter.

Current Value

Displays the live calculated process value, using the existing 4 mA = , 20 mA = and Units settings.

New Value

Enter the desired new reading for the process value, and then click Continue.

At the end of the calibration, the display will tell you if the calibration was successful or if the calibration failed. If successful, click Close to resume control. If failed, refer to Section 8 for troubleshooting help.

1 Pt Cal (Fluorometer Mode)

The 1-Point Calibration allows you to adjust the current reading of the process value to match what the actual value is as measured by some independent method (such as a laboratory measurement or handheld instrument). The software will maintain the “4 mA =” setting used to scale the input, and adjust the “20 mA =” setting to make the reading accurate at the value entered in the 1-Point Calibration. A new window will open when you click the 1 Pt Cal button.

Current mA

Displays a live reading of the mA output of the transmitter.

Product Level

Displays the live calculated process value, using the existing 4 mA = , 20 mA = and Dye/Product Ratio settings.

New Value

Enter the desired new reading for the ppb of fluorescent dye.

Dye/Product Ratio

The Dye-to-Product ratio is the ratio of the fluorescent dye in ppb to the active ingredient in the chemical product in ppm. Type the ratio (given to you by your chemical supplier). Click Continue.

At the end of the calibration, the display will tell you if the calibration was successful or if the calibration failed. If successful, click Close to resume control. If failed, refer to Section 8 for troubleshooting help.

Reset Defaults

If for any reason you want to go back to factory default settings for the calibration coefficients, click on the Reset Defaults button. You will be asked to verify that you want to change the calibration. Click Yes to continue. Another window will popup to tell you that the calibration was successful.

6.12 Flow Meter (Digital) Input Menu

All flow meters connected to digital inputs will be configured in this menu. Each meter will have a separate section. The sections available for a contact meter will differ than those for a paddlewheel meter.

Volume Units

Click on the radio button to select volume in units of *Gallons*, *Liters* or *Cubic Meters*. If you change the units in this screen, changes will not occur on the page until the “Submit” button is pressed.

Custom Name

Type in the text box a name to describe the flow meter.

Total/Reset Total

The Total displays the volume of solution to pass the flow meter since the last time the totalizer was reset.

If you want to reset the total, click on the “Reset Total” button.

Last Total Reset

Displays the date and time that the totalizer was last reset.

Rate (only appears if the water meter type is selected as ‘Paddlewheel’)

Displays the current water flow rate through the water meter.

Status

Possible status messages are; Normal (everything is OK) or Circuit Board Failure (Digital Inputs 1-6 only). See section 8.1 for a complete description of error messages.

Volume per Contact (appears only if the Contact type is selected)

Type the volume of solution that needs to flow through the flow meter before the meter sends a contact into the text box. The controller uses this information to update the totalizer.

K Factor (appears only if the Paddlewheel type is selected)

Type the K factor (number of pulses per unit volume) of your flow meter into the text box. Consult the documentation for the flow meter for information on what the K factor will be for your particular pipe size and installation. The K factor allows the controller to translate pulses from the meter into gallons or liters. Any value between 0.001 and 20,000 is acceptable.

Total Alarm Limit

Type in the text box the total volume of solution to pass the flow meter before setting off an alarm. If you do not need an alarm to occur at any given volume, entering 0 will disable the alarm.

Rate High-High Alarm Limit (appears only if the Paddlewheel type is selected)

Type in the text box the process value above which you want a high-high alarm to occur.

Rate High Alarm Limit (appears only if the Paddlewheel type is selected)

Type in the text box the process value above which you want a high alarm to occur.

Rate Low Alarm Limit (appears only if the Paddlewheel type is selected)

Type in the text box the process value below which you want a low alarm to occur.

Rate Low-Low Alarm Limit (appears only if the Paddlewheel type is selected)

Type in the text box the process value below which you want a low-low alarm to occur.

Alarm Dead Band (appears only if the Paddlewheel type is selected)

Type in the text box the dead band to be used for each alarm set point.

Damping (appears only if the Paddlewheel type is selected)

Damping is applied to the input by taking a running average of the readings of the input signal over the time frame specified by the damping setting (0-60 seconds). The averaged reading is displayed and used for control. Type in the text box the desired time frame.

Backup Sensor Mode (appears only if the Paddlewheel type is selected)

The redundant sensor algorithm will allow the user to define a primary sensor to use for control and a backup sensor. If the primary sensor goes invalid, the backup sensor will automatically take over control, and the sensor error alarm will activate. If the sensors don't match each other within user-defined limits but both are valid readings, control will stop and a Sensor Deviated alarm will activate. If the backup sensor goes invalid while the primary sensor is OK, control continues but the sensor error alarm will activate. If both sensors are invalid, control stops and the sensor error alarms activate.

To select this sensor as the backup sensor, click the Backup radio button, then click on the Submit button at the bottom of the page. The page will reload showing the status of the sensor as Backup, and offer additional menus:

Primary Sensor Assignment (appears only if the Paddlewheel type is selected)

This menu only appears if the Redundant Sensor Setting is Backup.

Use the pulldown arrow to select the sensor to use as the primary control sensor. All sensors of the same type as the backup sensor will appear in the pulldown list.

Deviation from Primary Sensor (appears only if the Paddlewheel type is selected)

This menu only appears if the Redundant Sensor Setting is Backup.

Type the maximum allowable difference between the two sensor readings. If this deviation is exceeded, then control of any outputs using the sensor will stop and an alarm activated.

6.13 Interlock Menu

The Interlock feature allows you to use a contact closure to shut down certain control outputs. For example, a dry contact from a DCS could be sent when the process is shutdown for maintenance, or a flow switch could stop control based upon a stagnant sample.

Digital Inputs

Displays which digital input has been selected as an Interlock input in the digital input section of the Start Up page.

Outputs Interlocked

Click on the check box to the left of the relays that you want to be deactivated when the dry contact signal is received by the controller. Clicking once places a check in the box, clicking again removes the check from the box.

Interlock when contact is

Click on the radio button that describes how your Interlock switch operates. If the contact is open when you want the outputs to deactivate, click on “open”. Otherwise, click on “closed”.

Click on the “Submit” button to save the changes.

6.14 Feed Verification Input Menu

Digital Inputs

Displays which digital inputs have been defined as Feed Verification inputs in the start up page.

Output

Click on the arrow for the pull-down list to tell the controller that the Feed Verification device for the digital input shown to left is attached to the relay that you selected.

Control-Output Status

This column lets you know if the control output for the pump to which the Feed Verification device is attached is currently on or off.

Feed Verification Status

This column lets you know if the Feed Verification device is sensing flow from the pump or not.

Vol. per Stroke

Type in the text box the volume of chemical that the metering pump delivers each time it strokes the diaphragm. This information is used to totalize the volume of chemical delivered, by multiplying the volume per stroke by the number of strokes counted by the Feed Verification device.

Alarm Time

Type in the text box the amount of time that can pass between the output relay being activated and the Feed Verification device sensing a stroke of the pump. If the pump is set to deliver 10 strokes per minute, then the controller must wait a minimum of 6 seconds before activating the alarm.

Total

This column tells you the volume of chemical that has been delivered by the metering pump. This value is calculated by multiplying the volume per stroke by the number of strokes counted by the Feed Verification device.

Last Reset Time

This column gives you the date and time that the total was last reset.

Reset Total

Click on the “Reset Total” button to reset the value in the “Total” column back to 0.0. Click on the “Submit” button to save the changes.

6.15 Level Switches (Digital) Input Menu

Digital Inputs

Displays which digital inputs are defined as level inputs.

Drum

Type in the text box the name of the container the level sensor to the left is measuring.

Status

Displays whether the drum is currently “Low” or “Normal.” Possible status messages for point level switches are; Normal, Low Alarm or Circuit Board Failure (Digital Inputs 1-6 only). See section 8.1 for a complete description of error messages.

Drum Low when Contact is

Click on the radio button that describes how your level switch operates. If the switch is closed when the drum is empty, select “closed”. If the switch is open when the drum is empty, select “open”.

Click on the “Submit” button to save the changes.

6.16 Generic (Digital) Inputs Menu

Digital Inputs

This column shows all digital inputs that have been defined as generic input types.

Custom Name

You may give the input a custom name by typing it in the text box.

Custom Message for Open Contact

You may specify a custom message to be displayed in the System Summary when the digital input contact is open. Type it in the text box.

Custom Message for Closed Contact

You may specify a custom message to be displayed in the System Summary when the digital input contact is closed. Type it in the text box.

Status

This column displays the current status of the digital input using the custom message.

Alarm Active when Contact is

Select the state of the digital input that corresponds to an alarm condition. If Open or Closed is selected, then when the switch is in that state the critical alarm action specified in the Alarm page will occur. If Neither is selected, then neither contact state will initiate the critical alarm action.

6.17 Counter Inputs Menu

Custom Name

You may give the input a custom name by typing it in the text box.

Total

The total number of counts since the last time the total was reset will be displayed here. The Reset Total button allows you to set the total back to 0.

Last Total Reset

The date and time of the last time the total was reset will be displayed here.

Rate

The current rate of contact closures will be displayed here. The unit of measure used is defined below.

Status

This menu reports the status of the input. Possible messages are Normal, High Alarm, Low Alarm, or Total Limit.

Rate Units

Select the units of measure that you want to use using the pull-down. The choices are pulses per second, minute, hour, day, week, month, or year.

One Count =

This menu allows you to specify that each count (contact closure) signifies a certain number of the custom units of measure. For example, one count could equal 100 liters of fluid.

Total Alarm Limit

You may specify a total number of counts accumulated above which an alarm message will occur. Type this in the text box. You must go to the Alarm page to specify that this alarm condition is a critical alarm in order to close the alarm relay or send an email or call a pager.

Rate High Alarm

You may specify a contact rate above which an alarm message will occur. Type this in the text box. You must go to the Alarm page to specify that this alarm condition is a critical alarm in order to close the alarm relay or send an email or call a pager.

Rate Low Alarm

You may specify a contact rate below which an alarm message will occur. Type this in the text box. You must go to the Alarm page to specify that this alarm condition is a critical alarm in order to close the alarm relay or send an email or call a pager.

6.18 Digital Inputs Menu

This page is used to assign the function of the devices attached to each digital input. These are normally already defined in the Start up page.

Use the pull-downs to define each input as *Not Used*, *Contacting Flow Meter*, *Paddlewheel Flow Meter*, *Counter*, *Interlock*, *Level Switch*, *Feed Verification* or *Generic Input*. Click on the “Submit” button to save the changes.

6.19 Relay (1 – 8) Output Menus – On/Off Set Point types

This page is used to select the set point, dead band, etc. Which units of measure appear depends upon how the input assigned to the relay is configured. If you make changes to the Input Assignment, you will need to click on the “Submit” button in order to see all the correct units.

You may also change the Relay Control Mode here. If you do, you will have to reselect the Input Assignment as well.

This section assumes that the Relay Control Mode is set to On/Off Set Point. Other control mode types are described in sections to follow.

Relay Control Mode

Click on the arrow of the pull down menu and select the way that you want to control the relay. See Section 6.2 for details on each control mode.

Relay Input Assignment

Click on the arrow of the pull down menu and select the input that will be used to control the relay. See Section 6.2 for details.

Current Reading

This field is for information only, and will display the calibrated reading from the sensor that is assigned to control the relay.

Status

This menu is for information only, and displays whether the output is “Off” or “On” and if on, for how much time, as well as any alarm conditions. Possible status messages are; Off, Off/Manual, On/Time counting up (if activated based on sensor input), Off/Time counting down or On/Time counting down/Hand (for manual relay activation). Possible error messages are Timeout and Interlock. See section 8.1 for a complete description of error messages.

Reset Timeout

There is a button called “Reset Timeout” which is used to reset the output if it has been activated for longer than the time limit imposed in the “Output Time Limit” menu described below.

Custom Name

This menu allows you to rename the output if desired. Type the new name into the text box.

Set Point

Type in the text box the process value at which you want the relay to activate. The set point value is limited to the range of the assigned input.

Control Direction

Click on the radio button to select between “Force Lower” or “Force Higher”.

Dead Band

Type in the text box the process value away from the set point at which the relay will deactivate. For example, if you are forcing the conductivity lower, your set point is 2000 $\mu\text{S}/\text{cm}$, and your dead band is 100 $\mu\text{S}/\text{cm}$, then the relay will activate at 2001 $\mu\text{S}/\text{cm}$ and deactivate at 1900 $\mu\text{S}/\text{cm}$. The purpose of the dead band is to prevent rapid cycling of the relay open and closed, which can shorten its life. The dead band should be set for the lowest value that still prevents the relay from chattering.

Mutual Interlocks

Click the check boxes to select or de-select the relays and analog output control outputs that you want to be prevented from turning ON if this output relay is already ON. If you do not need any other output to shut off when this relay turns on, UNCHECK all boxes. The selection is mutually exclusive, meaning that if Relay 2 has Relay 4 interlocked, then R2 won't turn on if R4 is already on, and R4 won't turn on if R2 is already on. This feature should be used with caution since it can potentially delay a chemical addition for a long time.

Output Time Limit

Type in the text box the maximum amount of time that the relay can be continuously activated before the controller deactivates the relay and activates an Output Time Limit alarm. This is intended to prevent the output from running out of control if the input fails in such a way that it will never deactivate the relay.

Note that the relay will not activate again until someone resets the timer!

It will take some experience to find out what the normal output on-time will be. If the relay cycles open and closed under worst case conditions in 30 minutes, you may want to set the Output Time Limit at 60 minutes.

Hand Time Limit

Type in the text box the maximum number of minutes that the relay can be activated in the Hand mode. Any value between 0 and 1440 is acceptable. A value of 0 means the relay can be left on indefinitely.

Click on the “Submit” button to save the changes.

Output Mode

Click on the radio buttons to manually control the relay. The normal selection will be *Auto*, where the controller uses the various set points to open and close the relay. You can force the relay closed regardless of the set points by selecting *Hand*, or force the relay open regardless of the set points by selecting *Off*.

If you select Off, the relay will not activate again until either Hand or Auto is selected (or if power is cycled)! If you select Hand, the relay will activate until either Auto or Off is selected, or until the Hand Time Limit (programmed in the next menu) expires or until the controller power is cycled.

The Off mode is handy to prevent the relay from activating while you are changing set points. The Hand mode is handy to be able to test the pump or valve, wiring, etc without needing to change set points.

Event Log

Click on the link to view the event log. The event log contains the date and time of each relay activation and deactivation, as well as the state of each Interlock, Level Switch, or Generic digital input.

Type of Event	Status to generate a ‘1’ in the log	Status to generate a ‘0’ in the log
Relay output	Relay activated	Relay not activated
Interlock DI	In the Interlock state as defined in the Interlock page	In the non-Interlock state as defined in the Interlock page
Level Switch DI	In the Low Alarm state as defined in the Level Switches page	In the Normal state as defined in the Level Switches page
Generic DI – Alarm selected	In the Alarm state as defined in the Generic Inputs page	In the Normal state as defined in the Generic Inputs page
Generic DI – No Alarm selected	Switch closed	Switch open

A window will open to ask if you would like to open the file or save it to disk. Select the method you would like to use. The file is .csv (comma separated variable) file that will open in a spreadsheet such as Excel.

6.20 Relay (1-8) Output Menus – Time Proportional Types

This page is used to select the set point, proportional band, etc. In time proportional control, the WebMasterONE will look at the process value and compare it to the set point value. If the set point is not satisfied, the controller will calculate an output on-time that will vary in proportion to the deviation from that set point. The user defines the time period, and the proportional band away from the set point where the relay will stay active for the entire time period.

Which units of measure appear depends upon how the input assigned to the relay is configured. If you make changes to the Input Assignment, you will need to click on the “Submit” button in order to see all the correct units.

You may also change the Relay Control Mode here. If you do, you will have to reselect the Input Assignment as well.

This section assumes that the Relay Control Mode is set to Time Proportional. Other control mode types are described in sections to follow.

Relay Control Mode

Click on the arrow of the pull down menu and select the way that you want to control the relay. See Section 6.2 for details on each control mode.

Relay Input Assignment

Click on the arrow of the pull down menu and select the input that will be used to control the relay. See Section 6.2 for details.

Current Reading

This field is for information only, and will display the calibrated reading from the sensor that is assigned to control the relay.

Status

This menu is for information only, and displays whether the output is “Off” or “On” and if on, for how much time, as well as any alarm conditions. Possible status messages are; Off, Off/Manual, On/Time counting up (if activated based on sensor input), or On/Time counting down/Hand (for manual relay activation). Possible error messages are Timeout and Interlock. See Section 8.1 for a complete description of error messages.

Reset Timeout

There is a button called “Reset Timeout” which is used to reset the output if it has been activated for longer than the time limit imposed in the “Output Time Limit” menu described below.

Custom Name

This menu allows you to rename the output if desired. Type the new name into the text box.

Set Point

Type in the text box the process value at which you want the relay to activate. The set point value is limited to the range of the assigned input.

Sample Period

Type in the text box the time span for the sample period. Refer to the example below under Proportional Band.

Proportional Band

Type in the text box the process value away from the set point at which the relay will be active for the entire sample period.

For example, if you are forcing the conductivity higher, your set point is 200 mS/cm, your sample period is one hour and your proportional band is 10 mS/cm. At the beginning of the sample period, the conductivity is 195 mS/cm. The relay will activate for 30 minutes, then deactivate for 30 minutes. If the conductivity is now 197.5 mS/cm, the relay will activate for 15 minutes and then deactivate for 45 minutes.

Control Direction

Click on the radio button to select between “Force Lower” or “Force Higher.”

Mutual Interlocks

Click the check boxes to select or de-select the relays and analog output control outputs that you want to be prevented from turning ON if this output relay is already ON. If you do not need any other output to shut off when this relay turns on, UNCHECK all boxes. The selection is mutually exclusive, meaning that if Relay 2 has Relay 4 interlocked, then R2 won't turn on if R4 is already on, and R4 won't turn on if R2 is already on. This feature should be used with caution since it can potentially delay a chemical addition for a long time.

Output Time Limit

Type in the text box the maximum amount of time that the relay can be continuously activated before the controller deactivates the relay and activates an Output Time Limit alarm. This is intended to prevent the output from running out of control if the input fails in such a way that it will never deactivate the relay.

Note that the relay will not activate again until someone resets the timer!

It will take some experience to find out what the normal output on-time will be. If the relay cycles open and close under worst case conditions in 30 minutes, you may want to set the Output Time Limit at 60 minutes.

Hand Time Limit

Type in the text box the maximum number of minutes that the relay can be activated in the Hand Mode. Any value between 0 and 1440 is acceptable. A value of 0 means the relay can be left on indefinitely.

Click on the “Submit” button to save the changes.

Output Mode

Click on the radio buttons to manually control the relay. The normal selection will be *Auto*, where the controller uses the various set points to open and close the relay. You can force the relay closed regardless of the set points by selecting *Hand*, or force the relay open regardless of the set points by selecting *Off*.

If you select *Off*, the relay will not activate again until either Hand or Auto is selected (or if power is cycled)! If you select *Hand*, the relay will activate until either Auto or Off is selected, or until the Hand Time Limit (programmed in the next menu) expires or until the controller power is cycled.

The *Off* mode is handy to prevent the relay from activating while you are changing set points. The *Hand* mode is handy to be able to test the pump or valve, wiring, etc. without needing to change set point.

Event Log

Click on the link to view the event log. The event log contains the date and time of each relay activation and deactivation, as well as the state of each Interlock, Level Switch, or Generic digital input.

Type of Event	Status to generate a '1' in the log	Status to generate a '0' in the log
Relay output	Relay activated	Relay not activated
Interlock DI	In the Interlock state as defined in the Interlock page	In the non-Interlock state as defined in the Interlock page
Level Switch DI	In the Low Alarm state as defined in the Level Switches page	In the Normal state as defined in the Level Switches page
Generic DI – Alarm selected	In the Alarm state as defined in the Generic Inputs page	In the Normal state as defined in the Generic Inputs page
Generic DI – No Alarm selected	Switch closed	Switch open

A window will open to ask if you would like to open the file or save it to disk. Select the method you would like to use. The file is .csv (comma separated variable) file that will open in a spreadsheet such as Excel.

6.21 Relay (1 – 8) Output Menus – Cycles of Concentration Types

This page is used to activate the relay based on a set point that is the ratio of two conductivity sensor input readings. This option is only available if at least two sensors are defined as conductivity sensors.

You may also change the Relay Control Mode here. If you do, you will have to reselect the Input Assignment as well.

This section assumes that the Relay Control Mode is set to Cycles of Concentration. Other control mode types are described in other sections of the manual.

Relay Control Mode

Click on the arrow of the pull down menu and select the way that you want to control the relay. See Section 6.2 for details on each control mode.

Sys. Cond. Input Assignment

Click on the arrow of the pull down menu to select the conductivity sensor that is installed in the cooling tower water.

Makeup Cond. Input Assignment

Click on the arrow of the pull down menu to select the conductivity sensor that is installed in the makeup water.

System Conductivity

This is a display of the current cooling tower system water conductivity as measured by the assigned sensor.

Makeup Conductivity

This is a display of the current makeup water conductivity as measured by the assigned sensor

Measured Cycles

This is a display of the current ratio of system conductivity to makeup conductivity.

Status

This displays the current status of the relay output, either “Off” or “On”, and if on, the amount of time it has been on. Possible status messages are Off, Off/Manual, On/Time counting down and On/Time counting down/Hand (for manual activation). The only possible error messages are Interlock, Timeout and Sensor Error. See section 8.1 for a complete description of error messages.

Custom Name

This menu allows you to call the output another name if desired. Type the new name in the text box.

Cycles Dead Band

Type in the desired dead band. See Cycles Set Point below.

Cycles Set Point

Type in the desired set point value. The control direction is always a High set point, so if the measured cycles exceeds the set point, the relay will activate until the measured cycles is less than the set point minus dead band.

Cycles Low/High Alarm

Type in the desired alarm points.

Mutual Interlocks

Click the check boxes to select or de-select the relays and analog output control outputs that you want to be prevented from turning ON if this output relay is already ON. If you do not need any other output to shut off when this relay turns on, UNCHECK all boxes. The selection is mutually exclusive, meaning that if Relay 2 has Relay 4 interlocked, then R2 won't turn on if R4 is already on, and R4 won't turn on if R2 is already on. This feature should be used with caution since it can potentially delay a chemical addition for a long time.

Output Time Limit

Type in the text box the maximum amount of time that the relay can be continuously activated before the controller deactivates the relay and activates an Output Time Limit alarm. This is intended to prevent the output from running out of control if the input fails in such a way that it will never deactivate the relay.

Note that the relay will not activate again until someone resets the timer!

It will take some experience to find out what the normal output on-time will be. If the relay cycles open and closed under worst case conditions in 30 minutes, you may want to set the Output Time Limit at 60 minutes.

Output Mode

Click on the radio buttons to manually control the relay. The normal selection will be *Auto*, where the controller uses the various set points to open and close the relay. You can force the relay closed regardless of the set points by selecting *Hand*, or force the relay open regardless of the set points by selecting *Off*.

If you select *Off*, the relay will not activate again until either *Hand* or *Auto* is selected (or if power is cycled)! If you select *Hand*, the relay will activate until either *Auto* or *Off* is selected, or until the *Hand Time Limit* (programmed in the next menu) expires or until the controller power is cycled.

The *Off* mode is handy to prevent the relay from activating while you are changing set points. The *Hand* mode is handy to be able to test the pump or valve, wiring, etc without needing to change set points.

Hand Time Limit

Type in the text box the maximum number of minutes that the relay can be activated in the *Hand* mode. Any value between 0 and 1440 is acceptable. A value of 0 means the relay can be left on indefinitely.

Click on the “Submit” button to save the changes.

Event Log

Click on the link to view the event log. The event log contains the date and time of each relay activation and deactivation, as well as the state of each Interlock, Level Switch, or Generic digital input.

Type of Event	Status to generate a ‘1’ in the log	Status to generate a ‘0’ in the log
Relay output	Relay activated	Relay not activated
Interlock DI	In the Interlock state as defined in the Interlock page	In the non-Interlock state as defined in the Interlock page
Level Switch DI	In the Low Alarm state as defined in the Level Switches page	In the Normal state as defined in the Level Switches page
Generic DI – Alarm selected	In the Alarm state as defined in the Generic Inputs page	In the Normal state as defined in the Generic Inputs page
Generic DI – No Alarm selected	Switch closed	Switch open

A window will open to ask if you would like to open the file or save it to disk. Select the method you would like to use. The file is .csv (comma separated variable) file that will open in a spreadsheet such as Excel.

6.22 Relay (1 – 8) Output Menus – Intermittent (Fixed Blowdown Time) Types

This page is used for boiler control where the conductivity is checked at intervals, and if found to be above the set point, the relay is activated for a fixed time. The following sequence occurs while sampling:

The relay activates to open the control valve, allowing a sample of the boiler water to flow past the electrode. The valve remains open for the time programmed in Duration of Sample.

The relay deactivates, and closes the control valve. The sample is held in the pipe for the time programmed in Hold Time.

At the end of the hold time, the controller reads the conductivity, and compares it to the set point value.

If it is above the set point, the relay activates and opens the valve for the time programmed in Blowdown Time.

The valve closes again and the sample is held again.

If the conductivity is still too high, the blowdown time repeats.

This continues until the conductivity is below the set point.

The valve closes and will not reactivate until the Interval Time has expired.

You may also change the Relay Control Mode here. If you do, you will have to reselect the Input Assignment as well.

This section assumes that the Relay Control Mode is set to Intermittent (Fixed Blowdown Time). Other control mode types are described in other sections of the manual.

Relay Control Mode

Click on the arrow of the pull down menu and select the way that you want to control the relay. See Section 6.2 for details on each control mode.

Relay Input Assignment

Click on the arrow of the pull down menu to select the sensor to be used to activate this relay.

Current Reading

This is a display of the current process value as measured by the assigned sensor.

Status

This displays the current status of the relay output, either “Off” or “On”, and if on, the amount of time it has been on. Possible status messages are Off, Off/Manual, On/Time counting down/Sampling, Off/Time counting down/Holding, On/Time counting down/Blowdown, Off/Time counting down/Waiting and On/Time counting down/Hand (for manual activation). The only possible error messages are Interlock and Sensor Error. See section 8.1 for a complete description of error messages.

Custom Name

This menu allows you to call the output another name if desired. Type the new name in the text box.

Set Point

Type in the desired set point value. The control direction is always Force Lower.

Interval Time

Type in the desired time between samples. Too short a time will waste water and drop the conductivity well below the set point. Too long a time will cause the conductivity to rise too high, potentially resulting in scale or carryover.

Duration of Sample

Type in the desired sample time. This should be as short as possible while still guarantying a fresh sample of boiler water at the electrode.

Hold Time

Type in the desired time to hold the water sample while it returns to boiler pressure.

Blowdown Time

Type in the desired time to blowdown if the conductivity is above the set point. Too long a time will waste water and drop the conductivity well below the set point. Too short a time could cause the conductivity to rise too high, potentially resulting in scale or carryover.

Mutual Interlocks

Click the check boxes to select or de-select the relays and analog output control outputs that you want to be prevented from turning ON if this output relay is already ON. If you do not need any other output to shut off when this relay turns on, UNCHECK all boxes. The selection is mutually exclusive, meaning that if Relay 2 has Relay 4 interlocked, then R2 won't turn on if R4 is already on, and R4 won't turn on if R2 is already on. This feature should be used with caution since it can potentially delay a chemical addition for a long time.

Output Mode

Click on the radio buttons to manually control the relay. The normal selection will be *Auto*, where the controller uses the various set points to open and close the relay. You can force the relay closed regardless of the set points by selecting *Hand*, or force the relay open regardless of the set points by selecting *Off*.

If you select *Off*, the relay will not activate again until either *Hand* or *Auto* is selected (or if power is cycled)! If you select *Hand*, the relay will activate until either *Auto* or *Off* is selected, or until the *Hand Time Limit* (programmed in the next menu) expires or until the controller power is cycled.

The *Off* mode is handy to prevent the relay from activating while you are changing set points. The *Hand* mode is handy to be able to test the pump or valve, wiring, etc without needing to change set points.

Hand Time Limit

Type in the text box the maximum number of minutes that the relay can be activated in the *Hand* mode. Any value between 0 and 1440 is acceptable. A value of 0 means the relay can be left on indefinitely.

Click on the "Submit" button to save the changes.

Event Log

Click on the link to view the event log. The event log contains the date and time of each relay activation and deactivation, as well as the state of each Interlock, Level Switch, or Generic digital input.

Type of Event	Status to generate a '1' in the log	Status to generate a '0' in the log
Relay output	Relay activated	Relay not activated
Interlock DI	In the Interlock state as defined in the Interlock page	In the non-Interlock state as defined in the Interlock page
Level Switch DI	In the Low Alarm state as defined in the Level Switches page	In the Normal state as defined in the Level Switches page
Generic DI – Alarm selected	In the Alarm state as defined in the Generic Inputs page	In the Normal state as defined in the Generic Inputs page
Generic DI – No Alarm selected	Switch closed	Switch open

A window will open to ask if you would like to open the file or save it to disk. Select the method you would like to use. The file is .csv (comma separated variable) file that will open in a spreadsheet such as Excel.

6.23 Relay (1 – 8) Output Menus – Intermittent (Proportional Blowdown Time) Types

This page is used for boiler control where the conductivity is checked at intervals, and if found to be above the set point, the relay is activated for a time that varies with the conductivity's deviation from the set point.

The following sequence occurs while sampling:

The relay activates to open the control valve, allowing a sample of the boiler water to flow past the electrode. The valve remains open for the time programmed in Duration of Sample.

The relay deactivates, and closes the control valve. The sample is held in the pipe for the time programmed in Hold Time.

At the end of the hold time, the controller reads the conductivity, and compares it to the set point value.

If it is above the set point, the relay activates and opens the valve for the time calculated using the Maximum Blowdown Time and Proportional Band.

The valve closes again and the sample is held again.

If the conductivity is still too high, the blowdown time is recalculated and the valve is opened for that time.

This continues until the conductivity is below the set point.

The valve closes and will not reactivate until the Interval Time has expired.

You may also change the Relay Control Mode here. If you do, you will have to reselect the Input Assignment as well.

This section assumes that the Relay Control Mode is set to Intermittent (Proportional Blowdown Time). Other control mode types are described in other sections of the manual.

Relay Control Mode

Click on the arrow of the pull down menu and select the way that you want to control the relay. See Section 6.2 for details on each control mode.

Relay Input Assignment

Click on the arrow of the pull down menu to select the sensor to be used to activate this relay.

Current Reading

This is a display of the current process value as measured by the assigned sensor.

Status

This displays the current status of the relay output, either “Off” or “On”, and if on, the amount of time it has been on. Possible status messages are Off, Off/Manual, On/Time counting down/Sampling, Off/Time counting down/Holding, On/Time counting down/Blowdown, Off/Time counting down/Waiting and On/Time counting down/Hand (for manual activation). The only possible error messages are Interlock and Sensor Error. See section 8.1 for a complete description of error messages.

Custom Name

This menu allows you to call the output another name if desired. Type the new name in the text box.

Set Point

Type in the desired set point value. The control direction is always Force Lower.

Interval Time

Type in the desired time between samples. Too short a time will waste water and drop the conductivity well below the set point. Too long a time will cause the conductivity to rise too high, potentially resulting in scale or carryover.

Duration of Sample

Type in the desired sample time. This should be as short as possible while still guarantying a fresh sample of boiler water at the electrode.

Hold Time

Type in the desired time to hold the water sample while it returns to boiler pressure.

Blowdown Time

Type in the desired maximum time to blowdown if the conductivity is above the set point. Too long a time will waste water and drop the conductivity well below the set point. Too short a time could cause the conductivity to rise too high, potentially resulting in scale or carryover.

Proportional Band

Type in the conductivity above the set point that will correlate to the maximum blowdown time.

For example, the set point is 2000 $\mu\text{S}/\text{cm}$, the proportional band is 100 $\mu\text{S}/\text{cm}$, and the maximum blowdown time is 30 minutes. If the conductivity measured is 2100 $\mu\text{S}/\text{cm}$ or above, the valve opens for 30 minutes. If the conductivity measured is 2050 $\mu\text{S}/\text{cm}$, the valve opens for 15 minutes. If the conductivity measured is 2000 $\mu\text{S}/\text{cm}$ or below, the valve remains closed and the Interval time counts down.

Mutual Interlocks

Click the check boxes to select or de-select the relays and analog output control outputs that you want to be prevented from turning ON if this output relay is already ON. If you do not need any other output to shut off when this relay turns on, UNCHECK all boxes. The selection is mutually exclusive, meaning that if Relay 2 has Relay 4 interlocked, then R2 won't turn on if R4 is already on, and R4 won't turn on if R2 is already on. This feature should be used with caution since it can potentially delay a chemical addition for a long time.

Output Mode

Click on the radio buttons to manually control the relay. The normal selection will be *Auto*, where the controller uses the various set points to open and close the relay. You can force the relay closed regardless of the set points by selecting *Hand*, or force the relay open regardless of the set points by selecting *Off*.

If you select Off, the relay will not activate again until either Hand or Auto is selected (or if power is cycled)! If you select Hand, the relay will activate until either Auto or Off is selected, or until the Hand Time Limit (programmed in the next menu) expires or until the controller power is cycled.

The Off mode is handy to prevent the relay from activating while you are changing set points. The Hand mode is handy to be able to test the pump or valve, wiring, etc without needing to change set points.

Hand Time Limit

Type in the text box the maximum number of minutes that the relay can be activated in the Hand mode. Any value between 0 and 1440 is acceptable. A value of 0 means the relay can be left on indefinitely.

Click on the "Submit" button to save the changes.

Event Log

Click on the link to view the event log. The event log contains the date and time of each relay activation and deactivation, as well as the state of each Interlock, Level Switch, or Generic digital input.

Type of Event	Status to generate a '1' in the log	Status to generate a '0' in the log
Relay output	Relay activated	Relay not activated
Interlock DI	In the Interlock state as defined in the Interlock page	In the non-Interlock state as defined in the Interlock page
Level Switch DI	In the Low Alarm state as defined in the Level Switches page	In the Normal state as defined in the Level Switches page
Generic DI – Alarm selected	In the Alarm state as defined in the Generic Inputs page	In the Normal state as defined in the Generic Inputs page
Generic DI – No Alarm selected	Switch closed	Switch open

A window will open to ask if you would like to open the file or save it to disk. Select the method you would like to use. The file is .csv (comma separated variable) file that will open in a spreadsheet such as Excel.

6.24 Relay (1 - 8) Output Menus – Flow Based Feed Type

This page is used to set the flow volume to trigger feed, feed time, etc. Which units of measure appear depends upon how the flow meter input assigned to the relay is configured. If you make changes to the Input Assignment, you will need to click on the “Submit” button in order to see all the correct units.

You may also change the Relay Control Mode here. If you do, you will have to reselect the Input Assignment as well.

This section assumes that the Relay Control Mode is set to Flow Based Feed. Other control mode types are described in other sections of the manual.

Relay Control Mode

Click on the arrow of the pull down menu and select the way that you want to control the relay. See Section 6.2 for details on each control mode.

Assign Makeup Meter (1-3)

Click on the arrow of the pull down menu and select the flowmeter inputs that will be used to control the relay. If only one flowmeter will control the relay, but more than one input is available, set them to Not Used. If more than one flowmeter is used, they should all have the same units of measure, and the controller will use the units of measure of Makeup Meter 1. See Section 6.2 for details.

Status

This displays the current status of the Relay Output, either “Off” or “On”, and if on, the time it has been on and any alarm conditions. Possible status messages are Off, Off/manual, On/Time counting down, Off/Time counting down or On/Time counting down/Hand (for manual relay activation). Possible error messages are Timeout, Interlock, or Pump Failure. See section 8.1 for a complete description of error messages.

Accumulated Volume

This displays the volume of flow that has accumulated so far towards triggering the next feed event. This is not the total flow, as seen in the System Summary page. This total will reset itself once the feed has occurred. You can manually reset this total using the “Reset Total” button to the right.

Custom Name

This menu allows you to call the output another name if desired. Type the new name in the text box.

Unit Volume to Trigger Output

Type in the text box the volume of solution that needs to enter the system in order to trigger the feed.

Output On-Time Per Unit Volume

Type in the text box the amount of time for the relay output to activate, once the previously specified volume of solution has entered the system. Any value between 1 and 1440 minutes is acceptable.

Reset Timeout

(only appears if the Output Time Limit below has been exceeded)

There is a button called “Reset Timeout” which is used to reset the output if it has been activated for longer than the time limit imposed in the “Output Time Limit” menu described below.

Mutual Interlocks

Click the check boxes to select or de-select the relays and analog output control outputs that you want to be prevented from turning ON if this output relay is already ON. If you do not need any other output to shut off when this relay turns on, UNCHECK all boxes. The selection is mutually exclusive, meaning that if Relay 2 has Relay 4 interlocked, then R2 won't turn on if R4 is already on, and R4 won't turn on if R2 is already on. This feature should be used with caution since it can potentially delay a chemical addition for a long time.

Output Time Limit

Type in the text box the maximum amount of time that the relay can be continuously activated before the controller deactivates the relay and activates an Output Time Limit alarm. This is intended to prevent the output from running out of control if the input fails in such a way that it will never deactivate the relay.

Note that the relay will not activate again until someone resets the timer!

It will take some experience to find out what the normal output on-time will be. If the relay cycles open and closed under worst case conditions in 30 minutes, you may want to set the Output Time Limit at 60 minutes.

Hand Time Limit

Type in the text box the maximum number of minutes that the relay can be activated in the Hand mode. Any value between 0 and 1440 is acceptable. A value of 0 means the relay can be left on indefinitely.

Click on the “Submit” button to save the changes.

Output Mode

Click on the radio buttons to manually control the relay. The normal selection will be *Auto*, where the controller uses the various set points to open and close the relay. You can force the relay closed regardless of the set points by selecting *Hand*, or force the relay open regardless of the set points by selecting *Off*.

If you select *Off*, the relay will not activate again until either *Hand* or *Auto* is selected (or if power is cycled)! If you select *Hand*, the relay will activate until either *Auto* or *Off* is selected, or until the Hand Time Limit (programmed in the next menu) expires or until the controller power is cycled.

The *Off* mode is handy to prevent the relay from activating while you are changing set points. The *Hand* mode is handy to be able to test the pump or valve, wiring, etc without needing to change set points.

Click on the “Submit” button to save the changes.

Event Log

Click on the link to view the event log. The event log contains the date and time of each relay activation and deactivation, as well as the state of each Interlock, Level Switch, or Generic digital input.

Type of Event	Status to generate a '1' in the log	Status to generate a '0' in the log
Relay output	Relay activated	Relay not activated
Interlock DI	In the Interlock state as defined in the Interlock page	In the non-Interlock state as defined in the Interlock page
Level Switch DI	In the Low Alarm state as defined in the Level Switches page	In the Normal state as defined in the Level Switches page
Generic DI – Alarm selected	In the Alarm state as defined in the Generic Inputs page	In the Normal state as defined in the Generic Inputs page
Generic DI – No Alarm selected	Switch closed	Switch open

A window will open to ask if you would like to open the file or save it to disk. Select the method you would like to use. The file is .csv (comma separated variable) file that will open in a spreadsheet such as Excel.

6.25 Relay (1-8) Output Menus – Feed With Another Relay Types

This page is used for relays that will be activated at the same time as another relay.

You may also change the Relay Control Mode here. If you do, you will have to reselect the Input Assignment as well.

This section assumes that the Relay Control Mode is set to Feed With Another Relay. Other control mode types are described in other sections of the manual.

Relay Control Mode

Click on the arrow of the pull down menu and select the way that you want to control the relay. See Section 6.2 for details on each control mode.

Assign Relay to Feed With

Click on the arrow of the pull down menu and select the relay that will be used to control this relay.

Status

This displays the current status of the relay output, either “Off” or “On”, and if on, the amount of time it has been on. Possible status messages are Off, Off/Manual, On/Time counting down and On/Time counting down/Hand (for manual activation). The only possible error message is Interlock. See section 8.1 for a complete description of error messages.

Custom Name

This menu allows you to call the output another name if desired. Type the new name in the text box.

Mutual Interlocks

Click the check boxes to select or de-select the relays and analog output control outputs that you want to be prevented from turning ON if this output relay is already ON. If you do not need any other output to shut off when this relay turns on, UNCHECK all boxes. The selection is mutually exclusive, meaning that if Relay 2 has Relay 4 interlocked, then R2 won't turn on if R4 is already on, and R4 won't turn on if R2 is already on. This feature should be used with caution since it can potentially delay a chemical addition for a long time.

Output Time Limit

Type in the text box the maximum amount of time that the relay can be continuously activated before the controller deactivates the relay and activates an Output Time Limit alarm. This is intended to prevent the output from running out of control if the input fails in such a way that it will never deactivate the relay.

Note that the relay will not activate again until someone resets the timer!

It will take some experience to find out what the normal output on-time will be. If the relay cycles open and closed under worst case conditions in 30 minutes, you may want to set the Output Time Limit at 60 minutes.

Output Mode

Click on the radio buttons to manually control the relay. The normal selection will be *Auto*, where the controller uses the various set points to open and close the relay. You can force the relay closed regardless of the set points by selecting *Hand*, or force the relay open regardless of the set points by selecting *Off*.

If you select *Off*, the relay will not activate again until either *Hand* or *Auto* is selected (or if power is cycled)! If you select *Hand*, the relay will activate until either *Auto* or *Off* is selected, or until the *Hand Time Limit* (programmed in the next menu) expires or until the controller power is cycled.

The *Off* mode is handy to prevent the relay from activating while you are changing set points. The *Hand* mode is handy to be able to test the pump or valve, wiring, etc without needing to change set points.

Hand Time Limit

Type in the text box the maximum number of minutes that the relay can be activated in the *Hand* mode. Any value between 0 and 1440 is acceptable. A value of 0 means the relay can be left on indefinitely.

Click on the "Submit" button to save the changes.

Event Log

Click on the link to view the event log. The event log contains the date and time of each relay activation and deactivation, as well as the state of each Interlock, Level Switch, or Generic digital input.

Type of Event	Status to generate a '1' in the log	Status to generate a '0' in the log
Relay output	Relay activated	Relay not activated
Interlock DI	In the Interlock state as defined in the Interlock page	In the non-Interlock state as defined in the Interlock page
Level Switch DI	In the Low Alarm state as defined in the Level Switches page	In the Normal state as defined in the Level Switches page
Generic DI – Alarm selected	In the Alarm state as defined in the Generic Inputs page	In the Normal state as defined in the Generic Inputs page
Generic DI – No Alarm selected	Switch closed	Switch open

A window will open to ask if you would like to open the file or save it to disk. Select the method you would like to use. The file is .csv (comma separated variable) file that will open in a spreadsheet such as Excel.

6.26 Relay (1 – 8) Output Menus – Feed After Another Relay (%) Types

This page is used to program to activate one relay for a percentage of the time that another relay had been activated. The first relay will activate, and its on-time recorded. When the first relay shuts off, the total on-time is calculated, and this relay is activated for the correct percentage of that time. If you make changes to the Input Assignment, you will need to click on the “Submit” button in order to see all the correct units.

You may also change the Relay Control Mode here. If you do, you will have to reselect the Input Assignment as well.

This section assumes that the Relay Control Mode is set to Feed After Another Relay. Other control mode types are described in other sections of the manual.

Relay Control Mode

Click on the arrow of the pull down menu and select the way that you want to control the relay. See Section 6.2 for details on each control mode.

Assign Relay to Feed After

Click on the arrow of the pull down menu and select the relay that will be used to control this relay.

Status

This displays the current status of the relay output, either “Off” or “On”, and if on, the amount of time it has been on. Possible status messages are Off, Off/Manual, On/Time counting down and On/Time counting down/Hand (for manual activation). The only possible error message is Interlock. See section 8.1 for a complete description of error messages.

Custom Name

This menu allows you to call the output another name if desired. Type the new name in the text box.

% of Relay to Feed

Use this menu to type in percentage of the assigned relay’s on-time desired for this relay.

Mutual Interlocks

Click the check boxes to select or de-select the relays and analog output control outputs that you want to be prevented from turning ON if this output relay is already ON. If you do not need any other output to shut off when this relay turns on, UNCHECK all boxes. The selection is mutually exclusive, meaning that if Relay 2 has Relay 4 interlocked, then R2 won't turn on if R4 is already on, and R4 won't turn on if R2 is already on. This feature should be used with caution since it can potentially delay a chemical addition for a long time.

Output Time Limit

Type in the text box the maximum amount of time that the relay can be continuously activated before the controller deactivates the relay and activates an Output Time Limit alarm. This is intended to prevent the output from running out of control if the input fails in such a way that it will never deactivate the relay.

Note that the relay will not activate again until someone resets the timer!

It will take some experience to find out what the normal output on-time will be. If the relay cycles open and closed under worst case conditions in 30 minutes, you may want to set the Output Time Limit at 60 minutes.

Output Mode

Click on the radio buttons to manually control the relay. The normal selection will be *Auto*, where the controller uses the various set points to open and close the relay. You can force the relay closed regardless of the set points by selecting *Hand*, or force the relay open regardless of the set points by selecting *Off*.

If you select *Off*, the relay will not activate again until either *Hand* or *Auto* is selected (or if power is cycled)! If you select *Hand*, the relay will activate until either *Auto* or *Off* is selected, or until the *Hand Time Limit* (programmed in the next menu) expires or until the controller power is cycled.

The *Off* mode is handy to prevent the relay from activating while you are changing set points. The *Hand* mode is handy to be able to test the pump or valve, wiring, etc without needing to change set points.

Hand Time Limit

Type in the text box the maximum number of minutes that the relay can be activated in the *Hand* mode. Any value between 0 and 1440 is acceptable. A value of 0 means the relay can be left on indefinitely.

Click on the "Submit" button to save the changes.

Event Log

Click on the link to view the event log. The event log contains the date and time of each relay activation and deactivation, as well as the state of each Interlock, Level Switch, or Generic digital input.

Type of Event	Status to generate a '1' in the log	Status to generate a '0' in the log
Relay output	Relay activated	Relay not activated
Interlock DI	In the Interlock state as defined in the Interlock page	In the non-Interlock state as defined in the Interlock page
Level Switch DI	In the Low Alarm state as defined in the Level Switches page	In the Normal state as defined in the Level Switches page
Generic DI – Alarm selected	In the Alarm state as defined in the Generic Inputs page	In the Normal state as defined in the Generic Inputs page
Generic DI – No Alarm selected	Switch closed	Switch open

A window will open to ask if you would like to open the file or save it to disk. Select the method you would like to use. The file is .csv (comma separated variable) file that will open in a spreadsheet such as Excel.

6.27 Relay (1-8) Output Menus – Feed After Another Relay (Fixed Time)

This page is used to program to activate one relay after another relay has been activated. The first relay will activate. When the first relay shuts off the second relay will activate for a programmable amount of time. If you make changes to the Input Assignment, you will need to click on the “Submit” button in order to see all the correct units.

You may also change the Relay Control Mode here. If you do, you will have to reselect the Input Assignment as well.

This section assumes that the Relay Control Mode is set to Feed After Another Relay (Fixed Time). Other control mode types are described in other sections of the manual.

Relay Control Mode

Click on the arrow of the pull down menu and select the way that you want to control the relay. See Section 6.2 for details on each control mode.

Assign Relay to Feed After

Click on the arrow of the pull down menu and select the relay that will be used to control this relay.

Status

This displays the current status of the relay output, either “Off” or “On”, and if on, the amount of time it has been on. Possible status messages are Off, Off/Manual, On/Time counting down and On/Time counting down/Hand (for manual activation). The only possible error message is Interlock. See section 8.1 for a complete description of error messages.

Custom Name

This menu allows you to call the output another name if desired. Type the new name in the text box.

Fixed Time to Feed

Use this menu to type the minutes and seconds of this relay’s on-time.

Mutual Interlocks

Click the check boxes to select or de-select the relays and analog output control outputs that you want to be prevented from turning ON if this output relay is already ON. If you do not need any other output to shut off when this relay turns on, UNCHECK all boxes. The selection is mutually exclusive, meaning that if Relay 2 has Relay 4 interlocked, then R2 won't turn on if R4 is already on, and R4 won't turn on if R2 is already on. This feature should be used with caution since it can potentially delay a chemical addition for a long time.

Output Time Limit

Type in the text box the maximum amount of time that the relay can be continuously activated before the controller deactivates the relay and activates an Output Time Limit alarm. This is intended to prevent the output from running out of control if the input fails in such a way that it will never deactivate the relay.

Note that the relay will not activate again until someone resets the timer!

It will take some experience to find out what the normal output on-time will be. If the relay cycles open and closed under worst case conditions in 30 minutes, you may want to set the Output Time Limit at 60 minutes.

Output Mode

Click on the radio buttons to manually control the relay. The normal selection will be *Auto*, where the controller uses the various set points to open and close the relay. You can force the relay closed regardless of the set points by selecting *Hand*, or force the relay open regardless of the set points by selecting *Off*.

If you select *Off*, the relay will not activate again until either *Hand* or *Auto* is selected (or if power is cycled)! If you select *Hand*, the relay will activate until either *Auto* or *Off* is selected, or until the *Hand Time Limit* (programmed in the next menu) expires or until the controller power is cycled.

The *Off* mode is handy to prevent the relay from activating while you are changing set points. The *Hand* mode is handy to be able to test the pump or valve, wiring, etc without needing to change set points.

Hand Time Limit

Type in the text box the maximum number of minutes that the relay can be activated in the *Hand* mode. Any value between 0 and 1440 is acceptable. A value of 0 means the relay can be left on indefinitely.

Click on the "Submit" button to save the changes.

Event Log

Click on the link to view the event log. The event log contains the date and time of each relay activation and deactivation, as well as the state of each Interlock, Level Switch, or Generic digital input.

Type of Event	Status to generate a '1' in the log	Status to generate a '0' in the log
Relay output	Relay activated	Relay not activated
Interlock DI	In the Interlock state as defined in the Interlock page	In the non-Interlock state as defined in the Interlock page
Level Switch DI	In the Low Alarm state as defined in the Level Switches page	In the Normal state as defined in the Level Switches page
Generic DI – Alarm selected	In the Alarm state as defined in the Generic Inputs page	In the Normal state as defined in the Generic Inputs page
Generic DI – No Alarm selected	Switch closed	Switch open

A window will open to ask if you would like to open the file or save it to disk. Select the method you would like to use. The file is .csv (comma separated variable) file that will open in a spreadsheet such as Excel.

6.28 Relay (1 – 8) Output Menus – Feed as % of Time Types

This page is used to program to activate one relay for a percentage of a user-specified time period.

You may also change the Relay Control Mode here. If you do, you will have to reselect the Input Assignment as well.

This section assumes that the Relay Control Mode is set to Feed as % of Time. Other control mode types are described in other sections of the manual.

Relay Control Mode

Click on the arrow of the pull down menu and select the way that you want to control the relay. See Section 6.2 for details on each control mode.

Status

This displays the current status of the relay output, either “Off” or “On”, and if on, the amount of time it has been on. Possible status messages are Off, Off/Manual, On/Time counting down and On/Time counting down/Hand (for manual activation). The only possible error message is Interlock. See section 8.1 for a complete description of error messages.

Custom Name

This menu allows you to call the output another name if desired. Type the new name in the text box.

Time Period

Type in the desired time period, between 1 and 1440 minutes. The relay will activate at the beginning of the time period, for the percentage of it specified below.

% of Period to Feed

Use this menu to type in the percentage of the time period that this relay will be active.

Mutual Interlocks

Click the check boxes to select or de-select the relays and analog output control outputs that you want to be prevented from turning ON if this output relay is already ON. If you do not need any other output to shut off when this relay turns on, UNCHECK all boxes. The selection is mutually exclusive, meaning that if Relay 2 has Relay 4 interlocked, then R2 won't turn on if R4 is already on, and R4 won't turn on if R2 is already on. This feature should be used with caution since it can potentially delay a chemical addition for a long time.

Output Time Limit

Type in the text box the maximum amount of time that the relay can be continuously activated before the controller deactivates the relay and activates an Output Time Limit alarm. This is intended to prevent the output from running out of control if the input fails in such a way that it will never deactivate the relay.

Note that the relay will not activate again until someone resets the timer!

It will take some experience to find out what the normal output on-time will be. If the relay cycles open and closed under worst case conditions in 30 minutes, you may want to set the Output Time Limit at 60 minutes.

Output Mode

Click on the radio buttons to manually control the relay. The normal selection will be *Auto*, where the controller uses the various set points to open and close the relay. You can force the relay closed regardless of the set points by selecting *Hand*, or force the relay open regardless of the set points by selecting *Off*.

If you select *Off*, the relay will not activate again until either *Hand* or *Auto* is selected (or if power is cycled)! If you select *Hand*, the relay will activate until either *Auto* or *Off* is selected, or until the *Hand Time Limit* (programmed in the next menu) expires or until the controller power is cycled.

The *Off* mode is handy to prevent the relay from activating while you are changing set points. The *Hand* mode is handy to be able to test the pump or valve, wiring, etc without needing to change set points.

Hand Time Limit

Type in the text box the maximum number of minutes that the relay can be activated in the *Hand* mode. Any value between 0 and 1440 is acceptable. A value of 0 means the relay can be left on indefinitely.

Click on the "Submit" button to save the changes.

Event Log

Click on the link to view the event log. The event log contains the date and time of each relay activation and deactivation, as well as the state of each Interlock, Level Switch, or Generic digital input.

Type of Event	Status to generate a '1' in the log	Status to generate a '0' in the log
Relay output	Relay activated	Relay not activated
Interlock DI	In the Interlock state as defined in the Interlock page	In the non-Interlock state as defined in the Interlock page
Level Switch DI	In the Low Alarm state as defined in the Level Switches page	In the Normal state as defined in the Level Switches page
Generic DI – Alarm selected	In the Alarm state as defined in the Generic Inputs page	In the Normal state as defined in the Generic Inputs page
Generic DI – No Alarm selected	Switch closed	Switch open

A window will open to ask if you would like to open the file or save it to disk. Select the method you would like to use. The file is .csv (comma separated variable) file that will open in a spreadsheet such as Excel.

6.29 Relay (1 – 8) Output Menus – Biocide Timer Based Types

This page is used to set the day and time to trigger feed, feed time, etc.

You may also change the Relay Control Mode here. If you do, you will have to reselect the Input Assignment as well.

This section assumes that the Relay Control Mode is set to Daily Biocide Timer, 1 Week Biocide Timer, 2 Week Biocide Timer, or 4 Week Biocide Timer. Other control mode types are described in other sections of the manual.

Relay Control Mode

Click on the arrow of the pull down menu and select the way that you want to control the relay. See Section 6.2 for details on each control mode.

Relay Input Assignment

Click on the arrow of the pull down menu and select the input that will be used to control the relay. See Section 6.2 for details. Biocide timers do not have an input assigned, they are activated based on a calendar.

Status

This displays the current status of the relay output, either “Off” or “On” and if on, the time it has been on and any alarm conditions. When the output is Off, the time until the next scheduled addition will be counting down. Possible status messages are Off., Off/Pending (time to add has come but output is interlocked), Off/manual, On/Time counting down or On/Time counting down/Hand (for manual relay activation). The only possible error message is Interlock. See section 8.1 for a complete description of error messages.

Custom Name

This menu allows you to call the output another name if desired. Type the new name in the text box.

Week 1-4 Schedule

(only appears if the Relay Control Mode is selected as Weekly, Bi-Weekly, or Monthly)

Day of Week: Click on the check box next to the days of the week during which you want a relay activation to occur. If a box is checked and you don't want an addition that day, click it to un-check the box.

Time: Type in the text boxes the hour and minute for the addition to occur. Use the arrow for the pull down menu to select between AM and PM.

On Time: Type in the text box the amount of time that you want the relay to be activated. Any value between 1 and 1440 is acceptable.

For Bi-Weekly or Monthly Modes, repeat this process for each week in the cycle.

Daily Schedule

(only appears if the Relay Control Mode is selected as Daily)

Additions: Click on the check box next to the additions that you want to occur every day. For example, if you want to activate the relay 4 times per day, check Additions A through D. If a check is in a box and you don't want that addition to happen, click on the box to un-check it.

Time: Type in the text boxes the hour and minute for the addition to occur. Use the arrow for the pull down menu to select between AM and PM.

On Time: Type in the text box the amount of time that you want the relay output to be active when it makes its addition. Any value between 1 and 1440 is acceptable.

Assign Bleed Lockout Relay

If you want to lockout bleed after the biocide addition, click on the arrow for the pull down menu and select the relay you have configured as the bleed relay (normally R1).

Bleed Lockout Time

If you want to lockout bleed after the biocide addition, type the desired lockout time (in minutes) in this text box.

Prebleed Type

If you want to bleed the system to drop the conductivity prior to the biocide addition, click on the radio button and select the method of prebleed desired.

Select **Not Used** if no prebleed is desired.

Select **Time Based** to open the bleed valve for a fixed amount of time prior to each biocide addition.

Select **Conductivity Based** to bleed until a conductivity set point is achieved prior to each biocide addition.

Assign Prebleed Relay (only appears if Prebleed is Used)

Click on the arrow of the pull down menu to select which relay is used for the Bleed function (normally R1).

Assign Prebleed Conductivity Input (only appears if Prebleed is Conductivity Based)

Click on the arrow of the pull down menu to select the sensor input which is used for system conductivity (normally S1).

Prebleed Conductivity (only appears if Prebleed is Conductivity Based)

Type the conductivity set point for the prebleed into the text box. This should be less than the normal bleed set point.

Prebleed Time Limit (only appears if Prebleed is Conductivity Based)

A time limit may be imposed on the conductivity based prebleed. If a system problem such as a faulty conductivity sensor or bleed valve prevents the prebleed conductivity from being achievable, the time limit will trigger the biocide add to occur.

Prebleed Time (only appears if Prebleed is Time Based)

Type the desired prebleed time (in minutes) in the text box.

Dispersant Addition

If you want to feed another chemical, such as a dispersant, penetrant or surfactant prior to the biocide addition, click on the radio button and select the method desired.

Select **Not Used** if no dispersant addition is desired.

Select **Before Biocide** to activate the dispersant relay for fixed amount of time prior to each biocide addition.

Select **After Biocide** to activate the dispersant relay for fixed amount of time after each biocide addition.

Assign Dispersant Relay

Click the arrow of the pull down menu to select the relay that will be used to feed the dispersant.

Mutual Interlocks

Click the check boxes to select or de-select the relays and analog output control outputs that you want to be prevented from turning ON if this output relay is already ON. If you do not need any other output to shut off when this relay turns on, UNCHECK all boxes. The selection is mutually exclusive, meaning that if Relay 2 has Relay 4 interlocked, then R2 won't turn on if R4 is already on, and R4 won't turn on if R2 is already on. This feature should be used with caution since it can potentially delay a chemical addition for a long time.

Output Mode

Click on the radio buttons to manually control the relay. The normal selection will be *Auto*, where the controller uses the various set points to open and close the relay. You can force the relay closed regardless of the set points by selecting *Hand*, or force the relay open regardless of the set points by selecting *Off*.

If you select *Off*, the relay will not activate again until either *Hand* or *Auto* is selected (or if power is cycled)! If you select *Hand*, the relay will activate until either *Auto* or *Off* is selected, or until the *Hand Time Limit* (programmed in the next menu) expires or until the controller power is cycled.

The *Off* mode is handy to prevent the relay from activating while you are changing set points. The *Hand* mode is handy to be able to test the pump or valve, wiring, etc without needing to change set points.

Hand Time Limit

Type in the text box the maximum number of minutes that the relay can be activated in the Hand mode. Any value between 0 and 1440 is acceptable. A value of 0 means the relay can be left on indefinitely.

Click on the “Submit” button to save the changes.

Event Log

Click on the link to view the event log. The event log contains the date and time of each relay activation and deactivation, as well as the state of each Interlock, Level Switch, or Generic digital input.

Type of Event	Status to generate a ‘1’ in the log	Status to generate a ‘0’ in the log
Relay output	Relay activated	Relay not activated
Interlock DI	In the Interlock state as defined in the Interlock page	In the non-Interlock state as defined in the Interlock page
Level Switch DI	In the Low Alarm state as defined in the Level Switches page	In the Normal state as defined in the Level Switches page
Generic DI – Alarm selected	In the Alarm state as defined in the Generic Inputs page	In the Normal state as defined in the Generic Inputs page
Generic DI – No Alarm selected	Switch closed	Switch open

A window will open to ask if you would like to open the file or save it to disk. Select the method you would like to use. The file is .csv (comma separated variable) file that will open in a spreadsheet such as Excel.

6.30 Relay (1 – 8) Output Menus – Spike Set Point Types

This page is used to activate the relay based on one set point for a majority of the time, and then spiking the concentration for a programmable amount of time, as often as once per day, on a one week, 2 week or 4 week schedule. This is typically an oxidizer addition based on an ORP electrode.

You may also change the Relay Control Mode here. If you do, you will have to reselect the Input Assignment as well.

This section assumes that the Relay Control Mode is set to Spike Set Point (1, 2 or 4 week cycle). Other control mode types are described in other sections of the manual.

Relay Control Mode

Click on the arrow of the pull down menu and select the way that you want to control the relay. See Section 6.2 for details on each control mode.

Relay Input Assignment

Click on the arrow of the pull down menu to select the sensor to be used to activate this relay.

Current Reading

This is a display of the current process value as measured by the assigned sensor.

Status

This displays the current status of the relay output, either “Off” or “On”, and if on, the amount of time it has been on. Possible status messages are Off, Off/Manual, On/Time counting down and On/Time counting down/Hand (for manual activation). The only possible error messages are Interlock, Timeout and Sensor Error. See section 8.1 for a complete description of error messages.

Custom Name

This menu allows you to call the output another name if desired. Type the new name in the text box.

Set Point

Type in the desired set point value. The control direction is selected below.

Dead Band

Type in the desired dead band. See Set Point above.

Spike Point

Type in the desired set point value for the spike in concentration.

Week 1-4 Schedule

Day of Week: Click on the check box next to the days of the week during which you want a relay activation to occur. If a box is checked and you don't want an addition that day, click it to un-check the box.

Time: Type in the text boxes the hour and minute for the addition to occur. Use the arrow for the pull down menu to select between AM and PM.

On Time: Type in the text box the amount of time that you want the relay to be activated. Any value between 1 and 1440 is acceptable.

For Bi-Weekly or Monthly Modes, repeat this process for each week in the cycle.

Control Direction

Click on the appropriate radio button. If the sensor reading naturally drops, and you want to bring it back up, select Force Higher.

Mutual Interlocks

Click the check boxes to select or de-select the relays and analog output control outputs that you want to be prevented from turning ON if this output relay is already ON. If you do not need any other output to shut off when this relay turns on, UNCHECK all boxes. The selection is mutually exclusive, meaning that if Relay 2 has Relay 4 interlocked, then R2 won't turn on if R4 is already on, and R4 won't turn on if R2 is already on. This feature should be used with caution since it can potentially delay a chemical addition for a long time.

Output Time Limit

Type in the text box the maximum amount of time that the relay can be continuously activated before the controller deactivates the relay and activates an Output Time Limit alarm. This is intended to prevent the output from running out of control if the input fails in such a way that it will never deactivate the relay.

Note that the relay will not activate again until someone resets the timer!

It will take some experience to find out what the normal output on-time will be. If the relay cycles open and closed under worst case conditions in 30 minutes, you may want to set the Output Time Limit at 60 minutes.

Output Mode

Click on the radio buttons to manually control the relay. The normal selection will be *Auto*, where the controller uses the various set points to open and close the relay. You can force the relay closed regardless of the set points by selecting *Hand*, or force the relay open regardless of the set points by selecting *Off*.

If you select *Off*, the relay will not activate again until either *Hand* or *Auto* is selected (or if power is cycled)! If you select *Hand*, the relay will activate until either *Auto* or *Off* is selected, or until the *Hand Time Limit* (programmed in the next menu) expires or until the controller power is cycled.

The *Off* mode is handy to prevent the relay from activating while you are changing set points. The *Hand* mode is handy to be able to test the pump or valve, wiring, etc without needing to change set points.

Hand Time Limit

Type in the text box the maximum number of minutes that the relay can be activated in the *Hand* mode. Any value between 0 and 1440 is acceptable. A value of 0 means the relay can be left on indefinitely.

Click on the “Submit” button to save the changes.

Event Log

Click on the link to view the event log. The event log contains the date and time of each relay activation and deactivation, as well as the state of each Interlock, Level Switch, or Generic digital input.

Type of Event	Status to generate a ‘1’ in the log	Status to generate a ‘0’ in the log
Relay output	Relay activated	Relay not activated
Interlock DI	In the Interlock state as defined in the Interlock page	In the non-Interlock state as defined in the Interlock page
Level Switch DI	In the Low Alarm state as defined in the Level Switches page	In the Normal state as defined in the Level Switches page
Generic DI – Alarm selected	In the Alarm state as defined in the Generic Inputs page	In the Normal state as defined in the Generic Inputs page
Generic DI – No Alarm selected	Switch closed	Switch open

A window will open to ask if you would like to open the file or save it to disk. Select the method you would like to use. The file is .csv (comma separated variable) file that will open in a spreadsheet such as Excel.

6.31 Relay (1 – 8) Output Menus – Dispersant Types

This page is used to activate the relay either before or after a Biocide Timer relay activates. This is normally used to feed a Dispersant, Penetrant or Surfactant to a cooling tower.

You may also change the Relay Control Mode here. If you do, you will have to reselect the Input Assignment as well.

This section assumes that the Relay Control Mode is set to Dispersant. Other control mode types are described in other sections of the manual.

Relay Control Mode

Click on the arrow of the pull down menu and select the way that you want to control the relay. See Section 6.2 for details on each control mode.

Relay Input Assignment

Click on the arrow of the pull down menu to select the input to be used to activate this relay. In dispersant mode, this is not applicable, the relay is activated directly before or after a biocide timer based relay.

Status

This displays the current status of the relay output, either “Off” or “On”, and if on, the amount of time it has been on. Possible status messages are Off, Off/Manual, On/Time counting down and On/Time counting down/Hand (for manual activation). The only possible error messages are Interlock, Timeout and Sensor Error. See section 8.1 for a complete description of error messages.

Custom Name

This menu allows you to call the output another name if desired. Type the new name in the text box.

On Time

Type the amount of feed time desired (in minutes) in the text box.

Mutual Interlocks

Click the check boxes to select or de-select the relays and analog output control outputs that you want to be prevented from turning ON if this output relay is already ON. If you do not need any other output to shut off when this relay turns on, UNCHECK all boxes. The selection is mutually exclusive, meaning that if Relay 2 has Relay 4 interlocked, then R2 won't turn on if R4 is already on, and R4 won't turn on if R2 is already on. This feature should be used with caution since it can potentially delay a chemical addition for a long time.

Output Time Limit

Type in the text box the maximum amount of time that the relay can be continuously activated before the controller deactivates the relay and activates an Output Time Limit alarm. This is intended to prevent the output from running out of control if the input fails in such a way that it will never deactivate the relay.

Note that the relay will not activate again until someone resets the timer!

It will take some experience to find out what the normal output on-time will be. If the relay cycles open and closed under worst case conditions in 30 minutes, you may want to set the Output Time Limit at 60 minutes.

Output Mode

Click on the radio buttons to manually control the relay. The normal selection will be *Auto*, where the controller uses the various set points to open and close the relay. You can force the relay closed regardless of the set points by selecting *Hand*, or force the relay open regardless of the set points by selecting *Off*.

If you select *Off*, the relay will not activate again until either *Hand* or *Auto* is selected (or if power is cycled)! If you select *Hand*, the relay will activate until either *Auto* or *Off* is selected, or until the Hand Time Limit (programmed in the next menu) expires or until the controller power is cycled.

The *Off* mode is handy to prevent the relay from activating while you are changing set points. The *Hand* mode is handy to be able to test the pump or valve, wiring, etc without needing to change set points.

Hand Time Limit

Type in the text box the maximum number of minutes that the relay can be activated in the *Hand* mode. Any value between 0 and 1440 is acceptable. A value of 0 means the relay can be left on indefinitely.

Click on the “Submit” button to save the changes.

Event Log

Click on the link to view the event log. The event log contains the date and time of each relay activation and deactivation, as well as the state of each Interlock, Level Switch, or Generic digital input.

Type of Event	Status to generate a ‘1’ in the log	Status to generate a ‘0’ in the log
Relay output	Relay activated	Relay not activated
Interlock DI	In the Interlock state as defined in the Interlock page	In the non-Interlock state as defined in the Interlock page
Level Switch DI	In the Low Alarm state as defined in the Level Switches page	In the Normal state as defined in the Level Switches page
Generic DI – Alarm selected	In the Alarm state as defined in the Generic Inputs page	In the Normal state as defined in the Generic Inputs page
Generic DI – No Alarm selected	Switch closed	Switch open

A window will open to ask if you would like to open the file or save it to disk. Select the method you would like to use. The file is .csv (comma separated variable) file that will open in a spreadsheet such as Excel.

6.32 Relay (1-8) Output Menus - Bleed Volume based on Makeup Volume

This page is used to activate the relay until a programmed volume of water flows through the bleed water meter(s). The relay activation is triggered by a programmed volume of makeup water flowing through the makeup water meter(s)

You may also change the Relay Control Mode here. If you do, you will have to reselect the Input Assignment as well.

This section assumes that the Relay Control Mode is set to Bleed Volume based on Makeup Volume. Other control mode types are described in other sections of the manual.

Relay Control Mode

Click on the arrow of the pull down menu and select the way that you want to control the relay. See Section 6.2 for details on each control mode.

Assign Makeup Meter 1, 2 or 3

Click on the arrow of the pull down menu to select the flow meter input to be used to activate this relay. Up to 3 flow meters may be assigned.

Assign Bleed Meter 1 or 2

Click on the arrow of the pull down menu to select the flow meter input to be used to activate this relay. Up to 3 flow meters may be assigned.

Status

This displays the current status of the relay output, either “Off” or “On”, and if on, the amount of time it has been on. Possible status messages are Off, Off/Manual, On/Time counting down and On/Time counting down/Hand (for manual activation). The only possible error messages are Interlock, Timeout and Sensor Error. See section 8.1 for a complete description of error messages.

Custom Name

This menu allows you to call the output another name if desired. Type the new name in the text box.

Accumulated Makeup

This displays the volume of makeup water that has accumulated since the last time the relay activated.

Accumulated Bleed

This displays the volume of bleed that has accumulated since the last time the relay activated.

Bleed Volume per Makeup Volume

Type the amount of water to bleed after the amount of makeup water comes in that is programmed below.

Makeup Volume

Type the amount of makeup water that will trigger the bleed relay.

Mutual Interlocks

Click the check boxes to select or de-select the relays and analog output control outputs that you want to be prevented from turning ON if this output relay is already ON. If you do not need any other output to shut off when this relay turns on, UNCHECK all boxes. The selection is mutually exclusive, meaning that if Relay 2 has Relay 4 interlocked, then R2 won't turn on if R4 is already on, and R4 won't turn on if R2 is already on. This feature should be used with caution since it can potentially delay a chemical addition for a long time.

Output Time Limit

Type in the text box the maximum amount of time that the relay can be continuously activated before the controller deactivates the relay and activates an Output Time Limit alarm. This is intended to prevent the output from running out of control if the input fails in such a way that it will never deactivate the relay.

Note that the relay will not activate again until someone resets the timer!

It will take some experience to find out what the normal output on-time will be. If the relay cycles open and closed under worst case conditions in 30 minutes, you may want to set the Output Time Limit at 60 minutes.

Output Mode

Click on the radio buttons to manually control the relay. The normal selection will be *Auto*, where the controller uses the various set points to open and close the relay. You can force the relay closed regardless of the set points by selecting *Hand*, or force the relay open regardless of the set points by selecting *Off*.

If you select *Off*, the relay will not activate again until either *Hand* or *Auto* is selected (or if power is cycled)! If you select *Hand*, the relay will activate until either *Auto* or *Off* is selected, or until the *Hand Time Limit* (programmed in the next menu) expires or until the controller power is cycled.

The *Off* mode is handy to prevent the relay from activating while you are changing set points. The *Hand* mode is handy to be able to test the pump or valve, wiring, etc without needing to change set points.

Hand Time Limit

Type in the text box the maximum number of minutes that the relay can be activated in the *Hand* mode. Any value between 0 and 1440 is acceptable. A value of 0 means the relay can be left on indefinitely.

Click on the "Submit" button to save the changes.

Event Log

Click on the link to view the event log. The event log contains the date and time of each relay activation and deactivation, as well as the state of each Interlock, Level Switch, or Generic digital input.

Type of Event	Status to generate a '1' in the log	Status to generate a '0' in the log
Relay output	Relay activated	Relay not activated
Interlock DI	In the Interlock state as defined in the Interlock page	In the non-Interlock state as defined in the Interlock page
Level Switch DI	In the Low Alarm state as defined in the Level Switches page	In the Normal state as defined in the Level Switches page
Generic DI – Alarm selected	In the Alarm state as defined in the Generic Inputs page	In the Normal state as defined in the Generic Inputs page
Generic DI – No Alarm selected	Switch closed	Switch open

A window will open to ask if you would like to open the file or save it to disk. Select the method you would like to use. The file is .csv (comma separated variable) file that will open in a spreadsheet such as Excel.

6.33 Relay (1- 8) Output Menu – Alarm Type

This page is used to set the alarm relay set points, etc.

You may also change the Relay Control Mode here. If you do, you will have to reselect the Input Assignment as well.

This section assumes that the Relay Control Mode is set to Alarm. Other control mode types are described in other sections of the manual.

Alarm Condition

In the left hand column, a list of all possible alarm conditions will be displayed. Only the alarm conditions that are possible given how your controller is configured will appear. To the right of each type of alarm condition there will be a column labeled Critical Alarm with a choice of “Yes” or “No”. Click on the “No” radio button if you do not want that type of alarm to activate this relay.

Status

This menu is for information only, and tells you if the alarm relay is currently on or off, and if it is on, for how much time. Possible status messages are Off, Off/Manual, On/Time counting up (indicating how long the alarm relay has been active) and On/Time counting down/Hand (for manual output activation).

Custom Name

This menu allows you to call the output another name if desired. Type the new name in the text box.

On-Delay Time

In order to avoid being notified of an alarm condition that quickly corrects itself, you set a delay time for the alarm action. If the alarm condition still exists at the end of the delay time, then the alarm relay will activate. If the alarm condition no longer exists at the end of the delay time, no notification will occur. Any value between 0 and 1440 minutes is acceptable.

Power-up Alarm Delay Time

In order to avoid being notified of an alarm condition that is only present because the system is just powering up, you set a delay time for the alarm action. If the alarm condition still exists at the end of the delay time, then the alarm relay will activate. If the alarm condition no longer exists at the end of the delay time, no notification will occur. Any value between 0 and 1440 minutes is acceptable.

If this Relay is a Dry Contact

Use this section if the relay board installed in this controller has a dry contact relay in the position of the relay being programmed as an alarm. If you look at the relay board, find the relay number you are programming as the alarm, and if it has terminals labeled NC and COM, it is dry contact.

Click on the radio button that describes how you want the alarm relay to act. The normal method is to close the relay when an alarm condition exists, but you can also open the relay.

If this Relay is Internally Powered

Use this section if the relay board installed in this controller has an internally powered relay in the position of the relay being programmed as an alarm. If you look at the relay board, find the relay number you are programming as the alarm, and if it has terminals labeled NC and NO, it is internally powered.

Click on the radio button that describes how you want the alarm relay to act. The normal method is to energize the NO (normally open) terminal when an alarm condition exists, but you can also energize the NC (normally closed) terminal.

Mutual Interlocks

Click the check boxes to select or de-select the relays and analog output control outputs that you want to be prevented from turning ON if this output relay is already ON. If you do not need any other output to shut off when this relay turns on, UNCHECK all boxes. The selection is mutually exclusive, meaning that if Relay 2 has Relay 4 interlocked, then R2 won't turn on if R4 is already on, and R4 won't turn on if R2 is already on. This feature should be used with caution since it can potentially delay a chemical addition for a long time.

Output Time Limit

Type in the text box the maximum amount of time that the relay can be continuously activated before the controller deactivates the relay and activates an Output Time Limit alarm. This is intended to prevent the output from running out of control if the input fails in such a way that it will never deactivate the relay. Any value between 0 and 1440 is acceptable. A value of 0 means the relay can be left on indefinitely.

Note that the relay will not activate again until someone resets the timer!

It will take some experience to find out what the normal output on-time will be. If the relay cycles open and closed under worst case conditions in 30 minutes, you may want to set the Output Time Limit at 60 minutes.

Output Mode

Click on the radio buttons to manually control the alarm relay. The normal selection will be *Auto*, where the controller uses the various set points to open and close the relay. You can force the relay open regardless of the presence of an alarm condition by selecting *Off*, or force the relay closed regardless of the presence of an alarm condition by selecting *Hand*.

If you select *Off*, the alarm relay will not be triggered again until either *Hand* or *Auto* is selected! If you select *Hand*, the relay will be closed until either *Auto* or *Off* is selected, or until the Hand Time Limit (programmed in the next menu) expires.

The *Off* mode is handy to use as an alarm silence. The *Hand* mode is handy to be able to test the relay, wiring, etc without needing to force an alarm condition.

Hand Time Limit

Type in the text box the maximum number of minutes that the alarm output can be activated in the Hand mode.

Click on the “Submit” button to save the changes.

Event Log

Click on the link to view the event log. The event log contains the date and time of each relay activation and deactivation, as well as the state of each Interlock, Level Switch, or Generic digital input.

Type of Event	Status to generate a ‘1’ in the log	Status to generate a ‘0’ in the log
Relay output	Relay activated	Relay not activated
Interlock DI	In the Interlock state as defined in the Interlock page	In the non-Interlock state as defined in the Interlock page
Level Switch DI	In the Low Alarm state as defined in the Level Switches page	In the Normal state as defined in the Level Switches page
Generic DI – Alarm selected	In the Alarm state as defined in the Generic Inputs page	In the Normal state as defined in the Generic Inputs page
Generic DI – No Alarm selected	Switch closed	Switch open

A window will open to ask if you would like to open the file or save it to disk. Select the method you would like to use. The file is .csv (comma separated variable) file that will open in a spreadsheet such as Excel.

6.34 Relay (1-8) Output Menus – Activate on a DI

In Activate on a DI mode the relay will activate in response to a selected Generic digital input switch changing state. The triggering state may be either switch open or switch closed

You may also change the Relay Control Mode here. If you do, you will have to reselect the Input Assignment as well.

This section assumes that the Relay Control Mode is set to Activate on a DI. Other control mode types are described in other sections of the manual.

Relay Control Mode

Click on the arrow of the pull down menu and select the way that you want to control the relay. See Section 6.2 for details on each control mode.

Relay Input Assignment

Click on the arrow of the pull down menu and select the input that will be used to control the relay. See Section 6.2 for details. Any Generic Input type of digital input may be used.

Status

This displays the current status of the relay output, either “Off” or “On”, and if on, the amount of time it has been on. Possible status messages are Off, Off/Manual, On/Time counting down and On/Time counting down/Hand (for manual activation). The only possible error messages are Relay or Analog Output Lockout and Timeout. See section 8.1 for a complete description of error messages.

Custom Name

This menu allows you to call the output another name if desired. Type the new name in the text box.

Digital Input Status

This menu shows the Open/Closed status of the digital input assigned to the relay.

Activate Relay when Switch is:

Click on the radio button to select whether to activate the relay when the assigned digital input is either open or closed.

On-Delay

To prevent the relay from chattering on and off in the event that the digital input assigned opens and closes rapidly, set either an on-delay or an off-delay (see below). Enter a value between 10 seconds and 1440 minutes in the text boxes. A value of 0 allows instantaneous response to the digital input.

Off-Delay

To prevent the relay from chattering on and off in the event that the digital input assigned opens and closes rapidly, set either an on-delay (see above) or an off-delay. Enter a value between 10 seconds and 1440 minutes in the text boxes. A value of 0 allows instantaneous response to the digital input.

Mutual Interlocks

Click the check boxes to select or de-select the relays and analog output control outputs that you want to be prevented from turning ON if this output relay is already ON. If you do not need any other output to shut off when this relay turns on, UNCHECK all boxes. The selection is mutually exclusive, meaning that if Relay 2 has Relay 4 interlocked, then R2 won't turn on if R4 is already on, and R4 won't turn on if R2 is already on. This feature should be used with caution since it can potentially delay a chemical addition for a long time.

Output Time Limit

Type in the text box the maximum amount of time that the relay can be continuously activated before the controller deactivates the relay and activates an Output Time Limit alarm. This is intended to prevent the output from running out of control if the input fails in such a way that it will never deactivate the relay. Any value between 0 and 1440 is acceptable. A value of 0 means the relay can be left on indefinitely.

Note that the relay will not activate again until someone resets the timer!

It will take some experience to find out what the normal output on-time will be. If the relay cycles open and closed under worst case conditions in 30 minutes, you may want to set the Output Time Limit at 60 minutes.

Output Mode

Click on the radio buttons to manually control the relay. The normal selection will be *Auto*, where the controller uses the various set points to open and close the relay. You can force the relay closed regardless of the set points by selecting *Hand*, or force the relay open regardless of the set points by selecting *Off*.

If you select Off, the relay will not activate again until either Hand or Auto is selected (or if power is cycled)! If you select Hand, the relay will activate until either Auto or Off is selected, or until the Hand Time Limit (programmed in the next menu) expires or until the controller power is cycled.

The Off mode is handy to prevent the relay from activating while you are changing set points. The Hand mode is handy to be able to test the pump or valve, wiring, etc without needing to change set points.

Hand Time Limit

Type in the text box the maximum number of minutes that the relay can be activated in the Hand mode.

Click on the “Submit” button to save the changes.

Event Log

Click on the link to view the event log. The event log contains the date and time of each relay activation and deactivation, as well as the state of each Interlock, Level Switch, or Generic digital input.

Type of Event	Status to generate a ‘1’ in the log	Status to generate a ‘0’ in the log
Relay output	Relay activated	Relay not activated
Interlock DI	In the Interlock state as defined in the Interlock page	In the non-Interlock state as defined in the Interlock page
Level Switch DI	In the Low Alarm state as defined in the Level Switches page	In the Normal state as defined in the Level Switches page
Generic DI – Alarm selected	In the Alarm state as defined in the Generic Inputs page	In the Normal state as defined in the Generic Inputs page
Generic DI – No Alarm selected	Switch closed	Switch open

A window will open to ask if you would like to open the file or save it to disk. Select the method you would like to use. The file is .csv (comma separated variable) file that will open in a spreadsheet such as Excel

6.35 Relay (1 - 8) Output Menus – Target PPM Feed Type

This page is used to set the flow volume to trigger feed, PPM set point, etc. Which units of measure appear depends upon how the flow meter input assigned to the relay is configured. If you make changes to the Input Assignment, you will need to click on the “Submit” button in order to see all the correct units.

You may also change the Relay Control Mode here. If you do, you will have to reselect the Input Assignment as well.

This section assumes that the Relay Control Mode is set to Target PPM Feed. Other control mode types are described in other sections of the manual.

Relay Control Mode

Click on the arrow of the pull down menu and select the way that you want to control the relay. See Section 6.2 for details on each control mode.

System Conductivity Input Assignment

Click on the arrow of the pull down menu and select the conductivity input that will be used to control the relay.

Makeup Conductivity Input Assignment

Click on the arrow of the pull down menu and select the conductivity input that will be used to control the relay. If Not Used is submitted, a field will appear for entering the makeup conductivity manually.

Assign Makeup Meter (1-3)

Click on the arrow of the pull down menu and select the flowmeter inputs that will be used to control the relay. If only one flowmeter will control the relay, but more than one input is available, set them to Not Used. See Section 6.2 for details.

Accumulated Volume

This displays the volume of flow that has accumulated so far towards triggering the next feed event. This is not the total flow, as seen in the System Summary page. This total will reset itself once the feed has occurred. You can manually reset this total using the “Reset Total” button to the right.

System Conductivity

This field displays the current system conductivity reading.

Makeup Conductivity

This field displays the current makeup conductivity reading.

Cycles

This field displays the current calculated cycles of concentration.

Status

This displays the current status of the Relay Output, either “Off” or “On”, and if on, the time it has been on and any alarm conditions. Possible status messages are Off, Off/manual, On/Time counting down, Off/Time counting down or On/Time counting down/Hand (for manual relay activation). Possible error messages are Timeout, Interlock, or Pump Failure. See section 8.1 for a complete description of error messages.

Custom Name

This menu allows you to call the output another name if desired. Type the new name in the text box.

Target PPM

Type in the text box the desired PPM set point for the product.

Unit Volume to Trigger Output

Type in the text box the volume of solution that needs to enter the system in order to trigger the feed.

Specific Gravity of Chemical Fed

Type in the text box the specific gravity of the product being fed.

Pump Flow Rate

Type in the text box the flow rate of the pump used to feed the product. For the best accuracy, the flow rate should be measured using a draw down cylinder with the pump discharge into normal system pressure.

Reset Timeout

(only appears if the Output Time Limit below has been exceeded)

There is a button called “Reset Timeout” which is used to reset the output if it has been activated for longer than the time limit imposed in the “Output Time Limit” menu described below.

Mutual Interlocks

Click the check boxes to select or de-select the relays and analog output control outputs that you want to be prevented from turning ON if this output relay is already ON. If you do not need any other output to shut off when this relay turns on, UNCHECK all boxes. The selection is mutually exclusive, meaning that if Relay 2 has Relay 4 interlocked, then R2 won't turn on if R4 is already on, and R4 won't turn on if R2 is already on. This feature should be used with caution since it can potentially delay a chemical addition for a long time.

Output Time Limit

Type in the text box the maximum amount of time that the relay can be continuously activated before the controller deactivates the relay and activates an Output Time Limit alarm. This is intended to prevent the output from running out of control if the input fails in such a way that it will never deactivate the relay.

Note that the relay will not activate again until someone resets the timer!

It will take some experience to find out what the normal output on-time will be. If the relay cycles open and closed under worst case conditions in 30 minutes, you may want to set the Output Time Limit at 60 minutes.

Hand Time Limit

Type in the text box the maximum number of minutes that the relay can be activated in the Hand mode. Any value between 0 and 1440 is acceptable. A value of 0 means the relay can be left on indefinitely.

Click on the “Submit” button to save the changes.

Output Mode

Click on the radio buttons to manually control the relay. The normal selection will be *Auto*, where the controller uses the various set points to open and close the relay. You can force the relay closed regardless of the set points by selecting *Hand*, or force the relay open regardless of the set points by selecting *Off*.

If you select Off, the relay will not activate again until either Hand or Auto is selected (or if power is cycled)! If you select Hand, the relay will activate until either Auto or Off is selected, or until the Hand Time Limit (programmed in the next menu) expires or until the controller power is cycled.

The Off mode is handy to prevent the relay from activating while you are changing set points. The Hand mode is handy to be able to test the pump or valve, wiring, etc without needing to change set points.

Click on the “Submit” button to save the changes.

Event Log

Click on the link to view the event log. The event log contains the date and time of each relay activation and deactivation, as well as the state of each Interlock, Level Switch, or Generic digital input.

Type of Event	Status to generate a ‘1’ in the log	Status to generate a ‘0’ in the log
Relay output	Relay activated	Relay not activated
Interlock DI	In the Interlock state as defined in the Interlock page	In the non-Interlock state as defined in the Interlock page
Level Switch DI	In the Low Alarm state as defined in the Level Switches page	In the Normal state as defined in the Level Switches page
Generic DI – Alarm selected	In the Alarm state as defined in the Generic Inputs page	In the Normal state as defined in the Generic Inputs page
Generic DI – No Alarm selected	Switch closed	Switch open

A window will open to ask if you would like to open the file or save it to disk. Select the method you would like to use. The file is .csv (comma separated variable) file that will open in a spreadsheet such as Excel.

6.36 Relay (1 - 8) Output Menus – Target PPM Feed with Feed Verification Type

This page is used to set the flow volume to trigger feed, PPM set point, etc. Which units of measure appear depends upon how the flow meter input assigned to the relay is configured. If you make changes to the Input Assignment, you will need to click on the “Submit” button in order to see all the correct units.

You may also change the Relay Control Mode here. If you do, you will have to reselect the Input Assignment as well.

This section assumes that the Relay Control Mode is set to Target PPM Feed with Feed Verification. Other control mode types are described in other sections of the manual.

Relay Control Mode

Click on the arrow of the pull down menu and select the way that you want to control the relay. See Section 6.2 for details on each control mode.

System Conductivity Input Assignment

Click on the arrow of the pull down menu and select the conductivity input that will be used to control the relay.

Makeup Conductivity Input Assignment

Click on the arrow of the pull down menu and select the conductivity input that will be used to control the relay. If Not Used is submitted, a field will appear for entering the makeup conductivity manually.

Assign Makeup Meter (1-3)

Click on the arrow of the pull down menu and select the flowmeter inputs that will be used to control the relay. If only one flowmeter will control the relay, but more than one input is available, set them to Not Used. See Section 6.2 for details.

Accumulated Volume

This displays the volume of flow that has accumulated so far towards triggering the next feed event. This is not the total flow, as seen in the System Summary page. This total will reset itself once the feed has occurred. You can manually reset this total using the “Reset Total” button to the right.

System Conductivity

This field displays the current system conductivity reading.

Makeup Conductivity

This field displays the current makeup conductivity reading.

Cycles

This field displays the current calculated cycles of concentration.

Status

This displays the current status of the Relay Output, either “Off” or “On”, and if on, the time it has been on and any alarm conditions. Possible status messages are Off, Off/manual, On/Time counting down, Off/Time counting down or On/Time counting down/Hand (for manual relay activation). Possible error messages are Timeout, Interlock, or Pump Failure. See section 8.1 for a complete description of error messages.

Custom Name

This menu allows you to call the output another name if desired. Type the new name in the text box.

Target PPM Set Point

Type in the text box the desired PPM set point for the product.

Unit Volume to Trigger Output

Type in the text box the volume of solution that needs to enter the system in order to trigger the feed.

Specific Gravity of Chemical Fed

Type in the text box the specific gravity of the product being fed.

Reset Timeout

(only appears if the Output Time Limit below has been exceeded)

There is a button called “Reset Timeout” which is used to reset the output if it has been activated for longer than the time limit imposed in the “Output Time Limit” menu described below.

Mutual Interlocks

Click the check boxes to select or de-select the relays and analog output control outputs that you want to be prevented from turning ON if this output relay is already ON. If you do not need any other output to shut off when this relay turns on, UNCHECK all boxes. The selection is mutually exclusive, meaning that if Relay 2 has Relay 4 interlocked, then R2 won't turn on if R4 is already on, and R4 won't turn on if R2 is already on. This feature should be used with caution since it can potentially delay a chemical addition for a long time.

Output Time Limit

Type in the text box the maximum amount of time that the relay can be continuously activated before the controller deactivates the relay and activates an Output Time Limit alarm. This is intended to prevent the output from running out of control if the input fails in such a way that it will never deactivate the relay.

Note that the relay will not activate again until someone resets the timer!

It will take some experience to find out what the normal output on-time will be. If the relay cycles open and closed under worst case conditions in 30 minutes, you may want to set the Output Time Limit at 60 minutes.

Hand Time Limit

Type in the text box the maximum number of minutes that the relay can be activated in the Hand mode. Any value between 0 and 1440 is acceptable. A value of 0 means the relay can be left on indefinitely.

Click on the “Submit” button to save the changes.

Output Mode

Click on the radio buttons to manually control the relay. The normal selection will be *Auto*, where the controller uses the various set points to open and close the relay. You can force the relay closed regardless of the set points by selecting *Hand*, or force the relay open regardless of the set points by selecting *Off*.

If you select Off, the relay will not activate again until either Hand or Auto is selected (or if power is cycled)! If you select Hand, the relay will activate until either Auto or Off is selected, or until the Hand Time Limit (programmed in the next menu) expires or until the controller power is cycled.

The Off mode is handy to prevent the relay from activating while you are changing set points. The Hand mode is handy to be able to test the pump or valve, wiring, etc without needing to change set points.

Click on the “Submit” button to save the changes.

Event Log

Click on the link to view the event log. The event log contains the date and time of each relay activation and deactivation, as well as the state of each Interlock, Level Switch, or Generic digital input.

Type of Event	Status to generate a '1' in the log	Status to generate a '0' in the log
Relay output	Relay activated	Relay not activated
Interlock DI	In the Interlock state as defined in the Interlock page	In the non-Interlock state as defined in the Interlock page
Level Switch DI	In the Low Alarm state as defined in the Level Switches page	In the Normal state as defined in the Level Switches page
Generic DI – Alarm selected	In the Alarm state as defined in the Generic Inputs page	In the Normal state as defined in the Generic Inputs page
Generic DI – No Alarm selected	Switch closed	Switch open

A window will open to ask if you would like to open the file or save it to disk. Select the method you would like to use. The file is .csv (comma separated variable) file that will open in a spreadsheet such as Excel.

6.37 Analog Output (1-4) Menu – Retransmit Mode (only appears if one or more 4-20 mA output option cards are installed)

4-20 mA Output Control Mode

Click on the pull-down to select between Not Used , Proportional Feed and Retransmit control mode. This section assumes that the control mode is set to retransmit.

Input Assignment

Click on the arrow to pull down the choices of which sensor measurement will be retransmitted as a 4-20 mA signal. The choices are any of the sensor inputs, any of the sensor's temperature compensation inputs, LSI, RSI, any paddlewheel flow meter or any 4-20 mA input signal (only if the 4-20 mA input option is installed).

Input Status

This column shows the status of the sensor that has been mapped to the 4-20 mA output. Possible messages include Normal, Unmapped, and Sensor Error.

Input Reading

This column shows the process value of the input that is mapped to the 4-20 mA output. This will be in units of conductivity, pH, ORP, temperature or whatever the 4-20 mA input is using for units of measure.

Output mA Value

This column shows the status of the 4-20 mA output in mA.

Output Status

This column shows the status of the 4-20 mA output in %, as well as any error messages. It will read Normal if the input value is between the two programmed values defining the 4-20 mA output, or Over Range if the input is above the 20 mA value, or Under Range if it is below the 4 mA value.

Custom Name

Type the name you want to use to identify this output into the text box.

4 mA Value

Type in the text box the input value that you want to correspond to a 4 mA output by the option card.

20 mA Value

Type in the text box the input value that you want to correspond to a 20 mA output by the option card.

4-20 mA Loop Cal

If the device connected to the controller's 4-20 mA output is not reading correctly, click on the Set 4 mA button and the controller will output a fixed 4 mA signal. The receiving device can then be calibrated to read correctly for a 4 mA signal. Then click the Set 20 mA button and the controller will output a fixed 20 mA signal.

Click on the Submit button to save the changes.

6.38 Analog Output Menus (1-4) - Proportional Feed Mode

(only appears if one or more 4-20 mA output option cards are installed)

In Proportional Feed mode the controller monitors an analog or sensor input and modulates an analog output to maintain a set point value. The analog output value is displayed in percent.

If you make changes to the Input Assignment, you will need to click on the "Submit" button in order to see all the correct units.

You may also change the 4-20 mA Output Control Mode here. If you do, you will have to reselect the Input Assignment as well.

This section assumes that the 4-20 mA Output Control Mode is set to Proportional Feed. Other control mode types are described in other sections of the manual.

Input Assignment

Click on the arrow of the pull down menu and select the analog or sensor input that will be used to modulate the analog output.

Custom Name

This menu allows you to call the output another name if desired. Type the new name in the text box.

Live Readings

These are for information only and display the sensor input reading, the sensor input status, the analog output mA value, and the analog output status.

Set Point

Type in the text box the process value at which you want the output to activate. The set point value is limited to the range of the assigned input.

Minimum Output Allowed

Type in the text box the lowest % output allowed for the analog output. Generally this will be 0%.

Maximum Output Allowed

Type in the text box the highest % output allowed for the analog output. Generally this will be 100%.

Input Value when Output is Max

Type in the test box the analog or sensor input value where the output needs to be at its maximum allowed value. This will set the control direction and the proportional band. If the process value will normal trend above the set point, and the desired action is to drive it back down, set the Input Value when Output is Max to a value greater than the set point. The closer this value is to the set point, the steeper the proportional response, and the more likely to overshoot the set point.

Damping

The response of the output to changes in the assigned input readings can be delayed by using the damping feature. Set to 0 and the output will respond immediately. Set above 0 and the readings will be averaged over that amount of time before calculating an output response.

Input Fault Value

If the analog output is suspended due to an error in the sensor or analog input signal, the Analog Output will default to this set value. Type the desired output in % in the text box. If you want the pump to shut off, enter 0%.

Interlock Value

If the analog output is Interlocked by a digital input, or a relay output, or by another analog output, the Analog Output will default to this set value. Type the desired output in % in the text box. If you want the pump to shut off, enter 0%.

During Input Calibration

Click on the radio button to select how you want the analog output to react during calibration of the input:

Remain Active: The Output % continues to respond to changes as normal.

Set Value: When the calibration begins the Output % is forced to the Input Cal Set Value (see below). Normal response resumes once the calibration is complete.

Last Value: When the calibration begins the Output % is frozen at the last value calculated before the calibration.

Normal response resumes once the calibration is complete.

Input Cal Set Value

Appears if the Set Value response is selected for During Input Calibration. Type the fixed output % desired during calibration of the sensor inputs.

Mutual Interlocks

Click the check boxes to select or de-select the relays and analog output control outputs that you want to be prevented from turning ON if this output is already ON. If you do not need any other output to shut off when this output turns on, UNCHECK all boxes. The selection is mutually exclusive, meaning that if Relay 2 has Relay 4 interlocked, then R2 won't turn on if R4 is already

on, and R4 won't turn on if R2 is already on. This feature should be used with caution since it can potentially delay a chemical addition for a long time.

Output Time Limit

Type in the text box the maximum amount of time that the output can be continuously activated before the controller deactivates the output (0% or 4 mA) and activates an Output Time Limit alarm. This is intended to prevent the output from running out of control if the input fails in such a way that it will never deactivate the output. Any value between 0 and 1440 is acceptable. A value of 0 means the output can be left on indefinitely.

Note that the output will not activate again until someone resets the timer!

It will take some experience to find out what the normal output on-time will be. If the output cycles on and off under worst case conditions in 30 minutes, you may want to set the Output Time Limit at 60 minutes.

Hand Time Limit

Type in the text box the maximum number of minutes that the output can be activated in the Hand mode.

Output Mode

Click on the radio buttons to manually control the output. The normal selection will be *Auto*, where the controller uses the various set points to modulate the output. You can force the output to a specific % regardless of the set points by selecting *Hand*, or force the output off (0%, or 4 mA) regardless of the set points by selecting *Off*.

If you select Off, the output will not respond again until either Hand or Auto is selected (or if power is cycled)! If you select Hand, the output will at a specific value (see Hand Mode Setting below) until either Auto or Off is selected, or until the Hand Time Limit (programmed in the previous menu) expires or until the controller power is cycled.

The Off mode is handy to prevent the output from responding while you are changing set points. The Hand mode is handy to be able to test the pump,, wiring, etc without needing to change set points.

Hand Value

Type in the text box the output % that the output will use when activated in the Hand mode.

4-20 mA Loop Cal

This menu is used to calibrate the device connected to the analog output. Click on Set 4 mA and the output will drive the loop with a fixed 4 mA of current. Click on Set 20 mA and the output will drive the loop with a fixed 20 mA of current.

6.39 Remote Alarming

Alarm Condition/Critical Alarm

In the left hand column, a list of all possible alarm conditions will be displayed. Only the alarm conditions that are possible given how your controller is configured will appear. To the right of each type of alarm condition there will be a column labeled Critical Alarm with a choice of “Yes” or “No”. Click on the “No” radio button if you do not want that type of alarm to be considered critical.

If an alarm condition is selected as a critical alarm, then you have the option of being notified that the alarm condition exists by sending an email.

The WebMasterOne will attempt to send the alarm message email five times at 5 minute intervals and will then stop trying, even if unsuccessful.

Define List of Events to Suppress Alarm

This column will provide a link to a list of all Interlock and Generic type digital inputs. Click on the radio button for any input you want to use to suppress that specific alarm condition. When the digital input is in its active state (open or closed, as defined in the digital input page) it will prevent an alarm message from being sent.

Alarm Action Status

This menu is for information only, and displays the status of the remote alarm notification. The possible messages to display are:

Alarm action completed:	The last alarm notification has already occurred and no further action is pending.
Found new alarm:	A new alarm has occurred and no notification has yet occurred.
Alarm due in HH:MM:SS	The alarm delay time will be displayed with time counting down.
Taking action:	The alarm notification is about to occur.
Sending email:	If notification is via email, this will be displayed.
Sending page:	If notification is via pager, this will be displayed.

Alarm Delay Time

In order to avoid being notified of an alarm condition that quickly corrects itself, you set a delay time for the alarm action. If the alarm condition still exists at the end of the delay time, then the alarm action will occur. If the alarm condition no longer exists at the end of the delay time, no notification will occur. Any value between 0 and 1440 minutes is acceptable.

Power-up Alarm Delay Time

In order to avoid being notified of an alarm condition that only exists because the system just powered up, you set a delay time for the alarm action. If the alarm condition still exists at the end of the delay time, then the alarm action will occur. If the alarm condition no longer exists at the end of the delay time, no notification will occur. Any value between 0 and 1440 minutes is acceptable.

Alarm Action Log File

Click the link to View Log File. The Alarm Log will tell you the status of any alarm emails that may have been sent. It will show you the date and time of the alarm, the method of alarm notification, whether it was successful at sending the message or not, and the type of alarm.

A window will open to ask if you would like to open the file or save it to disc. Select the method you would like to use. The file is a basic text file with a .log extension that may be opened in any word processing program (Word, Notepad, etc.).

6.40 LSI/RSI

(only appears if Include LSI/RSI information is set to Yes in the Startup Page)

This menu displays the calculated Ryznar's Stability Index and Langeliers Saturation Index and provides a place to enter the hardness and alkalinity wet test data used to calculate the indices.

RSI

The calculated value of the Ryznar's Stability Index is displayed here.

LSI

The calculated value of the Langeliers Saturation Index is displayed here.

Assign System Conductivity Input

Click on the arrow of the pull down menu to select the sensor input that is used for the System Conductivity.

Assign Makeup Conductivity Input

Click on the arrow of the pull down menu to select the sensor input that is used for the Makeup water Conductivity. If there is no makeup conductivity sensor installed, and it is necessary to manually enter the makeup conductivity, select Not Used.

Assign Temperature Input

Click on the arrow of the pull down menu to select the sensor input that is used for the temperature input. If there is no temperature sensor installed, and it is necessary to manually enter the temperature, select Not Used.

System Conductivity

The system conductivity reading from the selected conductivity sensor is displayed here.

Makeup Conductivity

The conductivity reading from the selected makeup water conductivity sensor is displayed here. If the sensor is Not Used, a text box will allow manual entry of the makeup conductivity.

System Temperature

The system temperature reading from the selected conductivity sensor is displayed here. If the sensor is Not Used, a text box will allow manual entry of the temperature.

Calcium Hardness (CaCO₃)

The actual wet test data for calcium hardness in ppm should be typed in this text box.

Total Alkalinity (CaCO₃)

The actual wet test data for total alkalinity in ppm should be typed in this text box.

Assign pH Input

Click on the arrow of the pull down menu to select the sensor input that is used for the pH. If there is no pH sensor installed, and it is necessary to manually enter the pH, select Not Used.

pH

The pH reading from the selected sensor is displayed here. If the sensor is Not Used, a text box will allow manual entry of the pH.

6.41 VTouch Config

(only appears if a VTouch activation is enabled from the Communications menu)

This menu is used to select the data that will be sent to and displayed on the VTouch web site. There is a list of all parameters available, with “Yes” and “No” radio buttons to select under a column called “Send to VTouch”. Select Yes for any parameter that should be displayed on the VTouch site.

When the Submit button is clicked, your changes will be saved, and a new VTouch Configuration packet will be sent to VTouch containing the names, units of measure, and the latest data for each parameter.

VTouch Communications Settings

This section is used to adjust the VTouch data update settings.

Enable Service

Use the pulldown to enable or disable the data updates.

Data Refresh Rate

Enter the number of minutes between data updates. In VCell activations, the minimum number is more limited.

Last Config Date & Time

This line displays the last time that a Configuration Packet was attempted to be sent. It will show “OK” if it was successful.

Last Data Date & Time

This line displays the last time that a Data Packet was attempted to be sent. It will show “OK” if it was successful.

Log

Click the Download Log link to download a CSV file that may be opened in Excel, that details the date and time of each packet sent and if it was successful or not.

6.42 System Status Auto-Reporting

The system status auto report is an email in html format that is a snapshot of current conditions, identical to what is displayed on the System Summary web page.

System Status Reporting

Click the appropriate radio button to select whether the report should be sent by email (Enable) or not (Disable).

Auto Report Log

Click the link to View Log File. The Auto Report Log will tell you the status of any report emails that may have been sent. It will show you the date and time of the report, the type of report, the method used to send it, whether it was successful at sending the message or not, and the reason for a failure if applicable.

A window will open to ask if you would like to open the file or save it to disc. Select the method you would like to use. The file is a basic text file with a .log extension that may be opened in any word processing program (Word, Notepad, etc.).

Status

This menu is informational only, telling you when the next report is due to be sent.

Reporting Mode

Click the appropriate radio button to select an Hourly, 12 Hours, Daily, Weekly, Biweekly, or Monthly report frequency. Type the time of day for receiving the report in the text boxes, and use the pull down menus to select the desired day, and to select AM or PM.

Important: If this unit is part of a network of controllers, you must stagger the reports from each controller in the network to occur at least an hour apart. Failure to do this could result in lost reports!

Report Testing

Click the Test Reporting button to see if the report will be sent correctly. The email address entered in the Communications page will be used. If you haven't already entered this information, go the Communications page and do so before trying a test report.

6.43 Datalog Auto Report

The other type of automatic report is a data log report. This report will email a data log file of any parameters selected. This file may be opened in a spreadsheet for graphing or other data manipulation. This report is sent on a cyclical schedule.

The Manual (see next section) and Auto Reporting data logs are dynamically connected to each other. For each data log, select the parameters to log, and the maximum time frame of the data log and submit the changes. The controller will calculate the minimum interval between data points based on available memory, memory required for each data log, and the settings for each data log. If your selections for this log use all of the memory available (25 MB), the other log will be disabled. Check the other log after making changes to this log to ensure that those revised settings are acceptable. If not, you may have to shorten the log duration for one or both of the logs in order to get more frequent data points.

Note that if you have a data log building, and you change the parameters to log, log duration or logging interval, any data previously gathered will be lost! If the changes to one log results in less memory being available for the other data log, the other log's minimum logging interval may change, erasing the other data log as well.

Data Log Reporting

Click the appropriate radio button to enable or disable the data log report feature.

Auto-Report Log File

Click on the link called Log to download the Auto-Report log. This log details the date and time of the report, which type of report was sent, how the report was sent (email via modem or email via Ethernet), if the report was sent successfully or not, and if not, what the problem was. You will be presented with the standard Windows dialog box, asking if you want to open the file or save it. If it's to be saved, it asks what the file should be named and where you want the file to go. This is a simple text

Logging Status

This menu is informational only, telling you if the auto report data log is enabled or not. Since the auto report log and the manual logs are tied together, if one log is reconfigured and uses up all available memory, the other log will be disabled.

Reporting Status

This menu is informational only, telling you when the next report is due to be sent.

Cyclical Log Duration

Select the maximum duration of the data log by clicking the radio button next to the time frame required. The choices are Monthly, Bi-Weekly, Weekly, Daily, Every 12 hours and Hourly. Also select the time of day for the report to be sent.

Important: If this unit is part of a network of controllers, you must stagger the reports from each controller in the network to occur at least an hour apart. Failure to do this could result in lost reports!

Minimum Logging Interval

The minimum time possible between data points will be calculated based upon the number of parameters selected to log between the Auto Report Datalog and the Manual Datalog, and the log durations.

Logging Interval

Type in the text box the time required between data points. If this is set to a particular value, and changes to the logging parameters results in a larger minimum interval, the time previously set will be replaced by the new minimum interval.

Datalogging Mode

If data needs to be logged at all times, select **Normal**.

If datalogging of some parameters needs to be suspended during an Interlock condition, or when a generic digital input is in a certain state, or when a relay is on or off (as in during a Probe Wash cycle, for example) or during an alarm condition, select **Suppressed by Events**. The data will be suppressed for as long as the trigger is active.

If the data needs to be collected only when triggered by an external event, such as an alarm condition or a signal from a dry contact switch connected to a digital input, click **Event Triggered**. The data will be collected for as long as the trigger is active.

Select items to log

You will be presented with a list of all of the parameters that can be logged, including sensor readings, totalizers, drum levels, and 4-20 mA inputs. The contents of the list will vary depending on what options you have installed or programmed. Click the “Yes” radio buttons of the parameters that you want to log, and the “No” radio buttons of the parameters that you do not want to log.

Suppresses Datalogging

This only appears if the Datalogging Mode is set to Suppressed by Events. A column to the right of each parameter will show a link to a page listing each event capable of suppressing the datalogging of that parameter. Place a check in the box to suppress logging of that parameter if that event is active.

Triggers Datalogging

This only appears if the Datalogging Mode is set to Event Triggered. Columns to the right of each parameter will show a link to a page listing each event capable of triggering the datalogging of that parameter. Place a check in the box to trigger logging of that parameter if that event is active.

Log Files

Links to the last two copies of the log files are saved in the event that the emails fail to be sent successfully. Click on the link to manually retrieve the file.

6.44 Manual Datalog

You may either download data files automatically, or manually. To have the data automatically sent to you via email, set up the data log in the Auto Reporting page (See Section 6.43).

The Manual and Auto Reporting data logs are dynamically connected to each other. For each data log, select the parameters to log, and the maximum time frame of the data log and submit the changes. The controller will calculate the minimum interval between data points based on available memory, memory required for each data log, and the settings for each data log. If your selections for this log use all of the memory available (25 MB), the other log will be disabled. Check the other log after making changes to this log to ensure that those revised settings are acceptable. If not, you may have to shorten the log duration for one or both of the logs in order to get more frequent data points

Note that if you have a data log building, and you change the parameters to log, log duration or logging interval, any data previously gathered will be lost! If the changes to one log results in less memory being available for the other data log, the other log's minimum logging interval may change, erasing the other data log as well.

The data is collected into a log file until the end of the maximum duration, or until a user downloads the file, whichever comes first. Once the log file is downloaded, it is erased and a new log file is started. If the file is not downloaded by the end of the maximum duration, the log file is saved and a new file is started. No more than two files may be stored at any time, so if the file is not downloaded by the time the second file is full, the first file is erased. Refer to the chart below.

Maximum Log Duration

Select the maximum duration of the data log by selecting the time frame from the pulldown list. The choices are 1 Month, 2 weeks, 1 week, 1 day, 12 hours and 1 hour.

Logging Status

This menu is informational only, telling you if the auto report data log is enabled or not. Since the auto report log and the manual logs are tied together, if one log is reconfigured and uses up all available memory, the other log will be disabled.

Minimum Logging Interval

The minimum time between data points will be calculated based upon the number of parameters selected to log between the Auto Report Datalog and the Manual Datalog, and the log durations.

Logging Interval

Type in the text box the time required between data points. If this is set to a particular value, and changes to the logging parameters results in a larger minimum interval, the time previously set will be replaced by the new minimum interval.

Datalogging Mode

If data needs to be logged at all times, select **Normal**.

If datalogging of some parameters needs to be suspended during an Interlock condition, or when a generic digital input is in a certain state, or when a relay is on or off (as in during a Probe Wash cycle, for example) or during an alarm condition, select **Suppressed by Events**. The data will be suppressed for as long as the trigger is active.

If the data needs to be collected only when triggered by an external event, such as an alarm condition or a signal from a dry contact switch connected to a digital input, click **Event Triggered**. The data will be collected for as long as the trigger is active.

Select items to log

You will be presented with a list of all of the parameters that can be logged, including sensor readings, totalizers, drum levels, and 4-20 mA inputs. The contents of the list will vary depending on what options you have installed or programmed. Click the “Yes” radio buttons of the parameters that you want to log, and the “No” radio buttons of the parameters that you do not want to log.

Suppresses Datalogging

This only appears if the Datalogging Mode is set to Suppressed by Events. Columns to the right of each parameter will show a link to a page listing each event capable of suppressing the datalogging of that parameter. Place a check in the box to suppress logging of that parameter if that event is active.

Triggers Datalogging

This only appears if the Datalogging Mode is set to Event Triggered. Columns to the right of each parameter will show a link to a page listing each event capable of triggering the datalogging of that parameter. Place a check in the box to trigger logging of that parameter if that event is active.

Log Files

Links to the last two copies of the log files are saved. Click on the link to manually retrieve the file.

Click on the “Submit” button to save the changes.

Scenario 1:

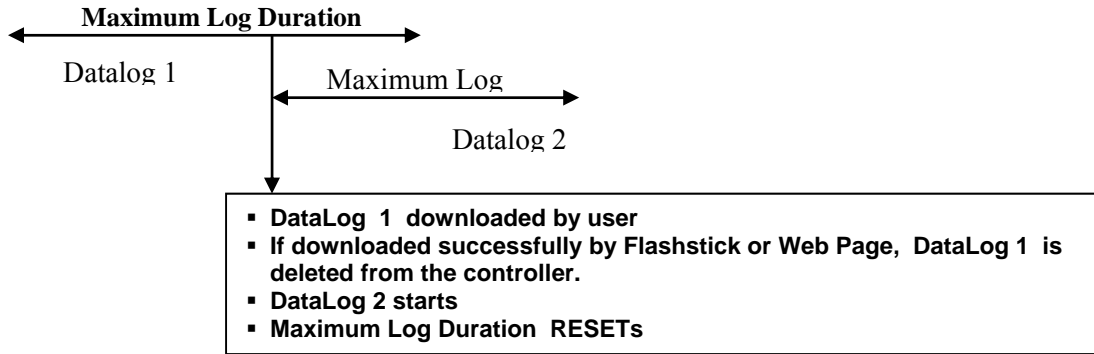

Scenario 2:

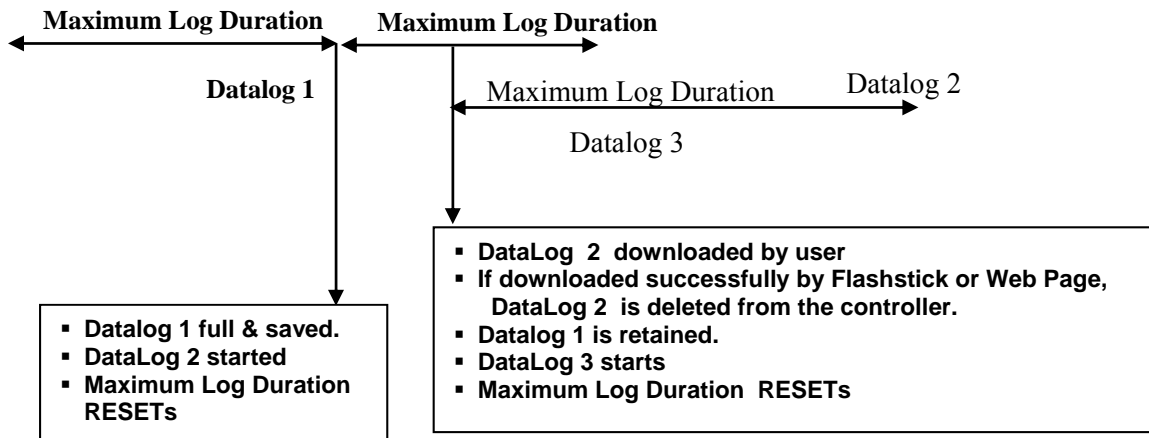

Scenario 3:

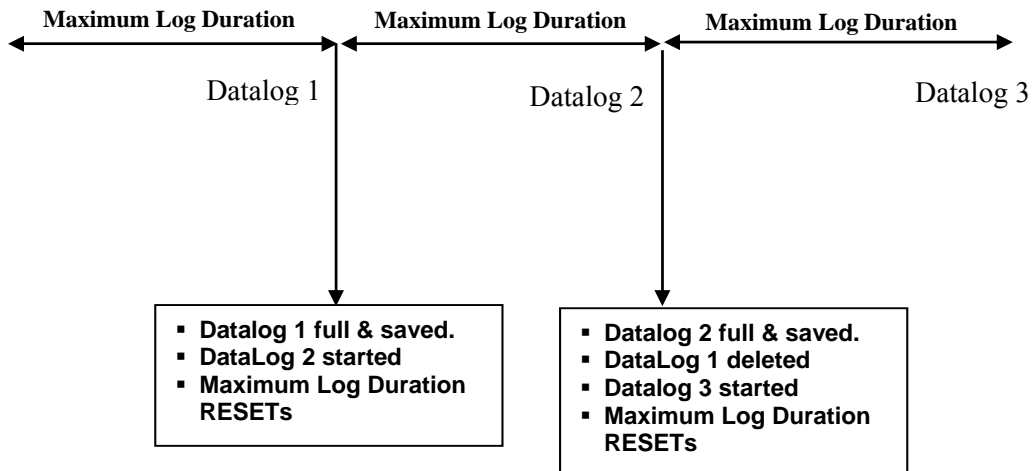

Log files that are actively filling will be erased (after a warning pop-up) if the user changes critical parameters such as:

- The parameter being logged
- The alarm used to trigger the log
- The logging duration
- The logging interval

Or for the related inputs used for alarm triggered logging

- The type of sensor or analog input
- The units of measure of the sensor or analog input
- The type of digital input of the trigger DI

The Logging Interval may increase automatically if the memory required for the Auto Report Data Log increases.

6.45 Graphing/Trending

Recent data may be viewed in a graphic format on-line without downloading it to a computer first, and without opening it in a spreadsheet.

At the top of the page, a selection of boxes will be displayed. Check the box of the parameter that you would like to see graphed. The choices will be any direct sensor input and any 4-20mA input that is being used. Then select the Time Span of the data by selecting it from the pull-down. The choices are Last Hour, Day, 7 Days, 14 Days and 32 Days.

Data points used in the graphs are taken every minute in the case of the Last Hour view, and every 10 minutes in the other views.

Click the Submit button for the changes to take effect.

The graphs selected will be presented below the check boxes on the web page. You may view details by moving your mouse over the portion of the graph that is of interest. The date, time and data of that coordinate will be displayed in the upper right hand corner of the graph.

The graph may be incorporated into a report document. Click on the "Export Graph" button. If you have a popup blocker installed, you will need to disable it. The graph will be converted to a jpg file and open in a new window. Click on File and Save as to save the image. You can also right-click the image, select copy, and then paste the image into your report.

6.46 Communications Menu

Internet Dial Up Account (only appears if a modem is installed)

Controller ISP User Name

When the controller needs to dial out and connect to the Internet Service Provider, it needs to identify itself with a user name, so that the ISP knows that it has an account. Type in the text box the user name that the controller will use.

Controller ISP Password

Similarly, the controller needs to identify itself with a password in order to connect with the ISP. Type in the text box the password that the controller will use. The password can also be changed here.

Primary ISP Phone No.

Type in the text box the access phone number for the controller's Internet Service Provider.

APN (only appears with GPRS activations)

Type in the text box the APN (Access Point Name) provided by the cell service provider.

Controller Phone No

When you need to communicate with the controller, you go to the web site, link to the WebMasterOne access page, and a call is made from our server to the controller to wake it up. Type in the text box the phone number for the line to which the WebMasterOne is connected. Use the pull down menu to select the country where the controller is located.

Custom Country Code

If the country code required is not in the pull-down list, select (Other) Customer Country Code from the pull-down and then enter the country code in the text box.

Ethernet (LAN)**Enable DHCP**

Click on the radio button to enable DHCP if you want the controller to obtain its IP address from the local area network. This option only works if the controller is connected to a LAN.

Ethernet IP Address

When a controller is attached to a network, your IT Administrator needs to assign it an Ethernet IP address. When you want to communicate with the controller from your PC on the network, you go to your Browser and type in the controller's address. Type that address into the text box.

Ethernet IP Netmask

When a controller is attached to a network, your IT Administrator must also assign the IP Netmask. Type the number assigned in the text box.

Ethernet Gateway

When a controller is attached to a network, your IT Administrator must also assign the Gateway. Type the number assigned in the text box.

Network Mode

If you have purchased the software to allow networking of controllers via Ethernet, use the pull down arrow to select the role that this controller will serve on the network. If it is not part of a network of WebMasterOne controllers, select "Independent". If it is the Master, select "Master". If it is the Slave, select "Slave". Once the network mode has been selected, the power to the controller must be cycled in order for the change to take effect.

Network Detection (only appears if the controller has master networking activated)

Click on the Detect Network button of the Master Controller and it will look at all of the devices that are connected to it, determine which devices are its slaves, and refresh the Sub-Network frame in the lower left corner of your browser with all of the slaves detected.

Email To Addresses**1st Address – 4th Address**

When the WebMasterOne needs to send an email for notification of an alarm condition, or to send out a scheduled report, these are the email addresses that it will use. Type in the text boxes the addresses to which you want the controller to send emails.

Cell Phone Text Message Addresses

The email message above is in html format and will not be displayed correctly on a cell phone. The cell phone text message email will be truncated. Data log and summary reports are not sent to these addresses, only alarm emails.

1st Address – 4th Address

Type in the text box the addresses for a text message to be sent. Up to four addresses are available.

Email and Text Message Settings

Controller Email Address

The controller needs to be given an email address, which your ISP uses to identify the controller as having an account, so that the ISP will accept the email that the controller is sending, and route it to the intended recipient. Type in the text box the controller's email address.

Send Email Via

If you have both a modem card and an Ethernet card installed, click on the radio button of which you need to use to send an email notification of an alarm condition, or an automatic report.

Email and Text Message Server Settings

SMTP IP Address

In order for the controller to send an email, the email must first be routed to the SMTP IP address that the Internet Service Provider specifies. Obtain this address from your ISP and type it into the text box.

SMTP Port

If the SMTP server being used requires a different port than the standard port 25, enter that in the text box.

ASMTTP Settings

ASMTTP User Name

Type in the user name required for authenticated SMTP emails.

ASMTTP Password

Type in the password required for authenticated SMTP emails.

Use ASMTTP for email

Check the box if your Internet service provider requires authenticated SMTP for its emails.

Communications Status

Gateway Access (VNet activations only)

This field is for information and displays if the controller is connected to the remote server or not and when the connection was made.

Connection Status

This menu is informational only, and tells you what is happening with the Internet connection. Possible status messages vary with the type of connection and include:

<u>Message</u>	<u>Explanation</u>
▪ Off Line	The controller is not connected.
▪ Dialing xxx-xxxx	The controller is dialing out to the ISP.
▪ No Dial Tone	The controller can not dial out due to phone line or modem problems.
▪ No phone number	There is nothing entered in the ISP Phone No. field.
▪ Connecting to ISP	The controller is successfully negotiating a connection with the ISP.
▪ On Line	The controller is now on the Internet.
▪ Checking for Upgrade	The controller is communicating with our server to see if a software upgrade is available.
▪ Connection Timeout in xxxxx sec	Once the Internet connection process is complete. The number of seconds displayed depends upon the value entered in the Connection Lifetime text box described below.

Dynamic IP Address

This menu is informational only, and tells you the IP address of the last person to contact the controller.

Last Connection Date and Time

This menu is informational only, and tells you when the controller was contacted last. Click on the “Submit” button to save the changes.

Connection Lifetime (PSTN or cell modem only)

This menu allows you to set a time limit on the Internet connection if no changes have been made. This will help control the cost of operating the controller if you forget to log off. Type in the text box the number of minutes that you want to pass by before disconnecting the Internet connection. Entering a connection lifetime of “0” means the connection will never timeout.

Manual Internet Connection (PSTN or cell modem only)

Click on the Connect button to manually test the WebMasterOne’s ability to successfully connect to the ISP. This is convenient on installation, or to troubleshoot Internet connection problems. The Connection Status field will display what is happening as described above. Once you see that the Connection Status is “On-line”, you may disconnect the controller from the Internet by clicking the Disconnect button.

Signal Strength Test

Click the Start Test button. It will prompt you to verify that you really want to start the setup. Click Yes and the test will begin. The controller will disconnect from the Internet and show the current signal strength in the Last Known Signal Strength field below.

Click on End Test when you have finished. The dialup status should return to “Off Line.”

Signal Strength Test Suggestion

This field will tell you whether the signal strength is Good, or if its Bad and you should try to relocate the antenna.

Last Known Signal Strength

This field will display the actual modem response string from the wireless modem. An rssi signal of 12-36 is good, the higher the number the better. If it's 12 then the signal is very marginal and you should attempt to improve it. A signal of 99 is very poor.

Internet Connection Log (PSTN or cell modem only)

Click on the link to view the Internet Connection log file. You will be prompted to either open the file (.csv format, normally opened in a spreadsheet) from its current location or to save the file to disk. Make your selection. The file will display the date and time of all Internet connections, the type of connection (ShoulderTap or Direct Modem) if the attempt was a success or a failure, and if it failed, what the failure mode was.

VNet Log (VNet activations only)

Click on the link to view the VNet Connection log file. You will be prompted to either open the file (.csv format, normally opened in a spreadsheet) from its current location or to save the file to disk. Make your selection. The file will display the date and time of the VNet connections, if the attempt was a success or a failure, and if it failed, what the failure mode was.

Activations

Enter Activation Key

Type the activation key code into this field and submit in order to activate any special software feature.

Upload Key File

Rather than type the key, a key file may be imported in order to activate a special software feature. Browse for the file, and once it is selected, click the Import Key File button.

Activation Status

For information, this field shows if any special software features have been activated.

Activation Log

Click on the Activations Log link to view the log file. You will be prompted to either open the file (.csv format, normally opened in a spreadsheet) from its current location or to save the file to disk. Make your selection. The file will show the status of past activation attempts.

Activation Table

The table will display a list of all activations, their key numbers, their status, and allows you to temporarily disable and re-enable the activation, or permanently delete the activation. **A deleted activation cannot be recovered and a new activation would need to be purchased to get the feature back!**

6.47 Advanced Comms

Internet Dialup (only appears if PSTN modem is installed)

Wait for dial tone before dialing

Click to place a check in the box if you want the modem to wait for a dial tone before calling out. In some countries the dial tone may not be recognized. If the modem will not recognize the dial tone, uncheck the box.

Modem Baud Rate

Click on the arrow of the pull-down to select different modem baud rates. The WebMaster modem is 38400. Normally there will be no reason to change the baud rate. The baud rate may be reduced if the process monitor is having problems at the higher speed due to poor phone line conditions. In the future, external modems may be supported that may not have the same baud rate.

Controller Telco Location

Click on the arrow of the pull-down to select the country where the process monitor is located.

Cellular Modem (only appears if cellular modem is installed)

Modem Initialization String

Type in the text box the modem initialization string required for your cell service. It will be in the format AT+CGDCONT=1,"IP","APN" where APN is the Access Point Name provided by the cell service provider.

SIM Card Number

For information only. The number is read from the SIM card.

Modem Type

Select between North America and Outside North America to specify the band of the cell modem.

Modem Band

Display the band of the modem.

Modem Baud Rate

Click on the arrow of the pull-down to select different modem baud rates. The baud rate will be negotiated at power-up. Normally there will be no reason to change the baud rate. The baud rate may be reduced if there are problems at the higher speed due to poor signal conditions.

Maximum PPP MTU Size

Normally the PPP MTU packet size will be negotiated with the cell service. Some services require a manual setting of a smaller size. Type this in the text box if necessary.

Network Settings

Primary and Secondary DNS IP Address

These text boxes contain the address of a valid Domain Name Server, which allows the WebAlert to send the emails using the name of the email server rather than the numeric SMTP IP address. The DNS IP addresses should never need to be changed, unless the server is experiencing problems.

Ethernet MAC Address

This field displays the MAC address of the Ethernet circuit, in case it is needed by the network IT administrator to identify the controller.

Gateway Port (only for VNet Activations)

Type the desired VNet port in the text box. This will normally not change from the default port of 1194.

Sub-Network Settings (only appears if the controller has master networking activated)

Mapped Internet IP Address

If you are accessing the master process monitor by using NAT to translate a real IP address to a fake IP address, then type the real IP address into this field of the master process monitor.

Direct Modem Connection (Point-to-Point)

Minimum required direct modem rings

The modem will answer after 4-9 rings. The default value is 7. If this is a problem because the phone system will not allow that many rings, type the new number into the text box.

Browser Settings

Java/Non-Java

If you are using Internet Explorer 7.0 or higher, or Mozilla Firefox, then Non Java should be selected. Check the radio button for Java to use Java for viewing live data. The choice depends upon the browser you will use. Java should only be selected if you are using Internet Explorer 5.0 or 6.0. You will need to have the Java Virtual Machine plug-in installed (available at www.java.com).

6.48 Configuration File Menu

If many of your applications are nearly identical, you can save a lot of time in the set up by downloading a typical configuration file to your hard drive, and later uploading the configuration file to another controller.

NOTE: If the software version of the controller that the configuration file was exported from is not the same as the controller it is imported to, the import will either fail, or not all settings will be modified. Use the software version in the name of the configuration file and export a new file for any new software version.

Export UCF

In order to transfer the User Configuration File (UCF) from the WebMasterONE to your computer, click the Export UCF link. You will be presented with the standard Windows dialog box to download a file. Click the radio button to Save this file to Disk, then click OK. Select the location where you want the file to be saved, change the name of the file if desired, then click Save. The file is only around 14KB, so it should be transferred relatively quickly. Click Close to close the dialog box.

The exact sequence of events and wording within the dialog box will vary depending upon the operating system (Windows 95, 98, NT, 2000, XP etc.) on your PC.

Browse

In order to transfer a previously saved UCF from your computer to this WebMasterONE, first click the Browse button to locate the file on your computer. A "Choose File" dialog box will open. Click on the correct file, then click Open.

Import UCF

Once the file name is displayed in the Browse text box, click the Import UCF button to transfer the file to the WebMasterONE.

6.49 Notepad

The configuration Notepad gives you a place to make notes regarding any changes that you have made to the set points, to document calibrations, system upsets or anything else that you want to note. Simply type your message into the text box.

6.50 Access Codes

There are three levels of access code protection. If the *Master* password is used in the WebMasterONE Authentication page, then any set point can be changed. If the *Calibration Level* password is used in the Authentication page, then sensor calibrations will be allowed, but other changes will not. If the *Read Only* password is used the user will be able to look at any page, but will not be allowed to make any changes.

In order to change the access code for each level of access, type the present password into the text box, then type the new password in the text box below. Type the new password again in the lowest text box to verify that the new password has been correctly entered.

The default user name is "webmaster" and the default passwords are "2001" for full access, "2002" for calibration only and "2003" for read only. These defaults can and should be changed to assure security.

Change User Log-in Name

You may also change the user name for logging into the WebMasterONE. Type the new user name into the text box.

Download Access Log

Click the link to View Log File. The Modem Access Log will tell you when the controller was accessed. It will show you the date and time of access, the method of access, the user name used, the IP address of the computer used for access, and the level of access code used (or that the attempt failed).

A window will open to ask if you would like to open the file or save it to disc. Select the method you would like to use. The file is a basic text file with a .log extension that may be opened in any word processing program (Word, Notepad, etc.).”

6.51 Software Upgrades (only appears if a newer revision of software is available)

Whenever you connect to the WebMasterONE via an Internet connection, it will check to see if any software upgrades are available. If there are, then the Software Upgrade page link will appear. Note that this can only occur if the controller is connected to the Internet, either through a modem or an Ethernet card.

If there is a newer version of software that you would like to load into your controller, then you can upgrade to the latest revision.

Click on the link “More Info on Software Upgrade” to see what features have been added.

Click on the link “Start Software Upgrade” in order to download the new version to the controller.

Note: Control is suspended during a software upgrade. If the controller being updated is a slave on a network of WebMasterONEs, both the master controller and the slave being updated will have control suspended during the upgrade process. Depending upon the extent of the changes and Internet traffic, the upgrade can take anywhere from 15 minutes to 2 hours to complete.

6.52 Sub-Network

Once you have created a network of two or more WebMasterONE controllers using Ethernet cards (see Figure 7 for wiring), purchased the Master Capability software for the master controller, defined the master unit as the master and slave units as slaves (see section 6.46) in the Communications page, and given each controller unique Ethernet IP addresses in the Communications page, then the links under Sub-Network will be active.

To navigate between controllers on the sub-network, start by logging onto the master controller. This may be via USB, Ethernet or modem. Once connected to the master, click on a link to the slave. The link will be given the custom name of the controller from the Startup page. The first time you connect to the slave in a given session, you will need to log on with that controller's user name and password. After that, you will be able to bounce from one controller to another without logging on again.

If the links available do not accurately match the controllers on the network, go to the Communications page and click the 'Detect Network' button. If the sub-network frame is still inaccurate, right click in the frame and click 'Refresh.' If still inaccurate, try rebooting the controller.

7.0 MAINTENANCE

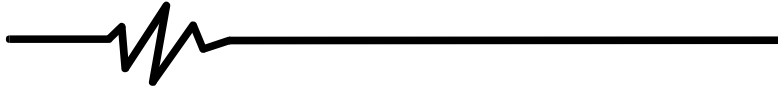

The WebMasterONE controller requires very little routine maintenance. The electronic enclosure only needs to be wiped down with a damp cloth to keep it clean. All other maintenance involves cleaning and calibrating sensors, described in detail below.



CAUTION! The WebMasterONE inner hinged face panel is secured with Phillips (#1) screws, which require a tool to open. No user adjustments are inside. This panel should only be opened by trained maintenance personnel.

7.1 Flow Switch Cleaning

The flow switch is designed to allow most particles to pass through, but it should occasionally be disassembled and cleaned. The frequency of cleaning required will vary with the cleanliness of the tower water. If the frequency of cleaning is excessive, and there are on-site personnel available, installation of a Y-strainer will reduce the time required for maintenance.

Refer to the exploded view drawing of the assembly on the following page.

To clean the flow switch, close the isolation valves to stop sample flow. Open the sample valve to relieve the pressure in the manifold. Remove the nut that holds the flow switch assembly in place. Pull the flow switch assembly straight up and out. The switch and the red float should come out together.

Clean the clear flow switch body with a bottle brush. Clean the switch/float assembly shaft with a cloth. If there is any build-up between the float and the switch shaft, remove the o-ring that retains the float on the shaft, and use a small bottle brush or compressed air to clean the inside of the float.

Reassemble all parts as shown in the exploded view diagram. Make sure that the sample valve is closed, open the isolation valves, and inspect for leaks.

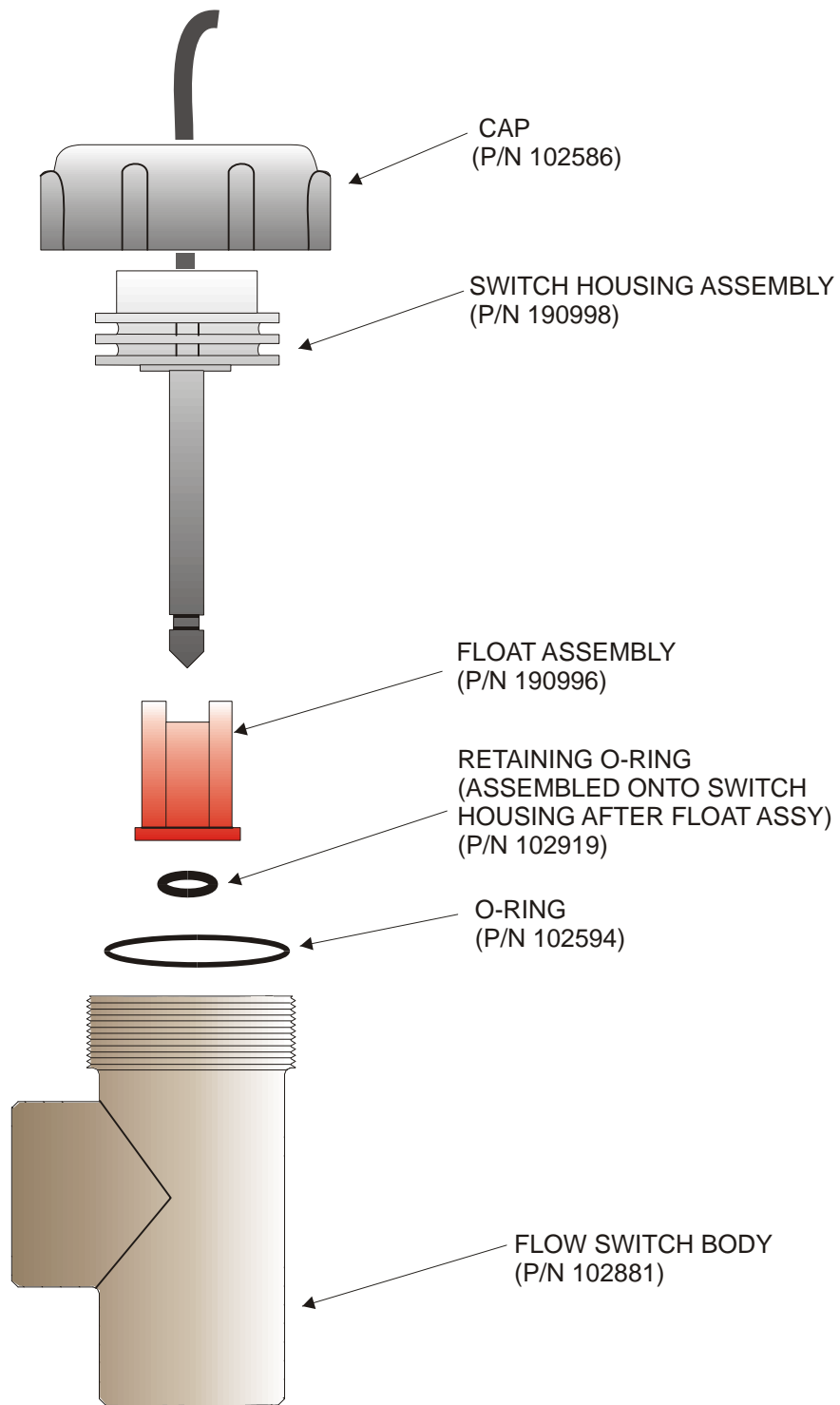

Figure 10 Flow Switch Assembly

7.2 Conductivity Sensor Cleaning and Calibration

Contacting Conductivity

The frequency of cleaning for the contacting conductivity electrode varies with each installation. The best way to determine the frequency is to compare the reading of the controller to the reading of a calibrated hand held instrument. When the two readings differ by an amount that you deem to be excessive (perhaps 5%), then it time to clean and recalibrate the electrode. The frequency should be every 2-3 months or so.

To clean the contacting conductivity electrode, close the isolation valves to stop sample flow. Open the sample valve to relieve the pressure in the manifold. Remove the nut that holds the electrode in place. Pull the electrode straight up and out.

For loose coatings, wipe with a cloth. Avoid smearing graphite from one electrode to the other. For removal of scale, dip in a dilute hydrochloric or gallic acid solution, and rinse. For oils (including fingerprints!) wash with a detergent.

Reassemble all parts. Note that the conductivity electrode is keyed to only reinsert in one orientation. Make sure that the sample valve is closed, open the isolation valves, and inspect for leaks.

After cleaning, it is necessary to recalibrate the electrode. This is only accurate when the electrode is installed in the piping.

High Temperature Contacting Conductivity

The frequency of cleaning for the contacting conductivity electrode varies with each installation. The best way to determine the frequency is to compare the reading of the controller to the reading of a calibrated hand held instrument. When the two readings differ by an amount that you deem to be excessive (perhaps 5%), then it time to clean and recalibrate the electrode. The frequency should be every 2-3 months or so.

To clean the high temperature contacting conductivity electrode, close the isolation valve(s) to stop sample flow. Open the manual blowdown bypass valve to relieve the pressure in the piping. Remove the electrode from the pipe.

For removal of scale, dip in a dilute hydrochloric or gallic acid solution, and rinse. For oils (including fingerprints!) wash with a detergent.

Replace the electrode in the pipe. Note that the sensor should be placed with the hole facing the direction of flow. Open the isolation valves and inspect for leaks.

After cleaning, it is necessary to recalibrate the electrode. This is only accurate when the electrode is installed in the piping.

Electrodeless Conductivity

The frequency of cleaning for the electrodeless conductivity electrode varies with each installation. The best way to determine the frequency is to compare the reading of the controller to the reading of a calibrated hand held instrument. When the two readings differ by an amount that you deem to be excessive (perhaps 5%), then it time to clean and recalibrate the electrode. The frequency should be every 6 months or so.

To clean the electrodeless conductivity sensor, close the isolation valves to stop sample flow. Open the sample valve to relieve the pressure in the manifold. Remove the nut that holds the sensor in place. Pull the sensor straight up and out.

For loose coatings, wipe with a cloth. Use a bottle brush to clean out the internal channels. For removal of scale, dip in a dilute hydrochloric or gallic acid solution, and rinse. The electrodeless sensor is immune to oily coatings.

Reassemble all parts. Make sure that the sample valve is closed, open the isolation valves, and inspect for leaks.

After cleaning, it is necessary to recalibrate the electrode. This is only accurate when the electrode is installed in the piping.

7.3 pH Electrode Cleaning and Calibration

The frequency of cleaning for the pH electrode varies with each installation. The best way to determine the frequency is to compare the reading of the controller to the reading of a calibrated hand held instrument. When the two readings differ by an amount that you deem to be excessive (perhaps 0.5 pH units), then it time to clean and recalibrate the electrode. This should be every 2-3 months.

To clean the pH electrode, close the isolation valves to stop sample flow. Open the sample valve to relieve the pressure in the manifold. Remove the nut that holds the electrode in place. Pull the electrode straight up and out.

For loose coatings, wipe with a cloth. Avoid rough handling of the pH sensitive glass. For removal of scale, dip in a dilute hydrochloric or gallic acid solution, and rinse. For oils (including fingerprints!) wash with a detergent or isopropyl alcohol.

Reassemble all parts. Make sure that the sample valve is closed, open the isolation valves, and inspect for leaks.

After cleaning, it is necessary to recalibrate the electrode. Refer to Section 6.5 for detailed calibration instructions.

7.4 ORP Electrode Cleaning and Calibration

The frequency of cleaning for the ORP electrode varies with each installation. The best way to determine the frequency is to verify that the desired oxidizer concentration is within your required limits when the controller indicates that the ORP is at the set point value. The frequency of cleaning should be every 2-3 months or so.

To clean the ORP electrode, close the isolation valves to stop sample flow. Open the sample valve to relieve the pressure in the manifold. Remove the nut that holds the electrode in place. Pull the electrode straight up and out.

For loose coatings, wipe the platinum tip with a cloth. For removal of scale, dip in a dilute hydrochloric or sulfuric acid solution, and rinse. For oils (including fingerprints!) wash with a detergent or isopropyl alcohol. For very stubborn coatings, jeweler's rouge may be used to polish the platinum tip.

Reassemble all parts. Make sure that the sample valve is closed, open the isolation valves, and inspect for leaks.

After cleaning, it is necessary to recalibrate the electrode. Refer to Section 6.6 for detailed calibration instructions.

7.5 Disinfection Sensor Cleaning and Calibration

The frequency of cleaning for the disinfection sensors varies with each installation. The best way to determine the frequency is to verify that the desired oxidizer concentration closely matches an offline analysis (such as a DPD test). When the two readings differ by an amount that you deem to be excessive then it time to clean and recalibrate the sensor. This should be every 2-3 months.

To clean the sensor, close the isolation valves to stop sample flow. Open the sample valve to relieve the pressure in the manifold. Remove the nut that holds the sensor in place. Pull the sensor straight up and out.

For loose coatings, wipe the membrane cap with a cloth, being careful not to damage it. For removal of scale, dip in a dilute hydrochloric or sulfuric acid solution, and rinse. For oils (including fingerprints!) wash with isopropyl alcohol. Do NOT use a detergent on the chlorine sensor!

Reassemble all parts. Make sure that the sample valve is closed, open the isolation valves, and inspect for leaks.

After cleaning, it is necessary to recalibrate the electrode. Refer to Section 6.7 for detailed calibration instructions. If this membrane cleaning does not correct the accuracy, replace the membrane cap as described in the sensor manual.

7.6 Replacing the Fuses

CAUTION: Disconnect power to the controller before opening the front panel!

Locate the fuses on the relay interface board on the lower left side of the back of the controller enclosure. See figure 5, Identification of Parts. Gently remove the old fuse from its retaining clip. You can verify that the fuse has been blown by measuring continuity between the ends of the fuse using an ohmmeter. If it is blown, discard. Press the new fuse into the clip, secure the front panel of the controller, and return power to the unit.

Warning! Use of non-approved fuses can affect product safety approvals. Specifications are shown below. To ensure that UL/CSA product safety certifications are maintained, it is recommended that a factory original fuse be used.

Fuse		P/N			
F1	Protects Power Input	102833	5 x 20 mm	1.6 amp	250 V
F3	Protects R1, R2, R3 and R4 relay outputs	102834	5 x 20 mm	6.3 amp	250 V
F2	Protects R5, R6, R7, and R8 relay outputs	102834	5 x 20 mm	6.3 amp	250 V

8.0 TROUBLESHOOTING

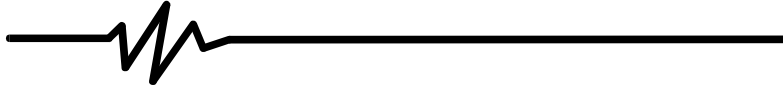

8.1 ERROR MESSAGES

Conductivity Calibration Failure

This error message occurs after calibration of the conductivity sensor. A clean sensor should give a predictable signal in a solution of known conductivity. If the calibration adjusts the signal more than 50% away from the predicted value, the calibration will fail. A signal this far off indicates a problem with the reading, and is not normal.

Possible Causes

Dirty sensor.

Incorrect sensor cable used.

Sensor cable disconnected.

Sensor cable connected incorrectly

Problem with hand-held instrument

Faulty sensor.

Faulty core interface circuit board (if Sensor 1).

Faulty sensor option circuit board (if Sensors 2-4).

In Boilers, Flashing

If Intermittent Sampling, faulty valve

Corrective Actions

Clean sensor as described in Section 7.2 above.

Refer to Installation Guidelines in Section 3.3.

Reconnect cable.

Check connections of all 6 wires against Fig 5

Refer to the troubleshooting guide for the hand held instrument used to determine the system conductivity.

Replace sensor.

Replace the core interface board.

Replace the sensor option board.

Refer to Installation Guidelines in Section 3.3

Check all upstream and downstream valves to ensure that a sample is reaching the sensor.

pH Calibration Failure

This error message occurs after attempting an electrode calibration. The normal slope of a pH electrode is 59 mV/pH unit. As the electrode ages, this slope will decrease. The WebMasterONE reports the % difference from the theoretical slope after each calibration. When the slope reaches 12 mV/pH unit (80% difference), the calibration fails.

Possible Causes

Dirty electrode.

Faulty electrode cartridge.

Sensor cable disconnected.

Faulty electrode housing.

Faulty core interface circuit board
(if Sensor 1).

Faulty sensor option circuit board
(if Sensors 2-4).

Corrective Actions

Clean electrode and recalibrate as described in Section 7.3 above.

Replace cartridge.

Reconnect cable. Also ensure that the electrode cartridge is tightly screwed into the electrode housing, and that the inside of the housing is dry. Make sure that the +/- 5 VDC and the IN-, IN+ wires are firmly attached.

If the controller passes self test, the wiring is correct, the +/- 5 VDC signal is present and the cartridge is attached and OK, replace the electrode housing.

Replace the core interface board.

Replace the sensor option board.

ORP Calibration Failure

This error message occurs after calibrating the ORP electrode. If the difference between the raw mV reading and the calibrated value exceeds 50%, then the calibration will fail.

Possible Causes

Dirty electrode.

Faulty electrode cartridge.

Sensor cable disconnected.

Faulty electrode housing.

Faulty core interface circuit board
(if Sensor 1).

Faulty sensor option circuit board
(if Sensors 2-4).

Corrective Actions

Clean electrode and recalibrate as described in Section 7.4 above.

Replace electrode cartridge.

Reconnect cable. Also ensure that the electrode cartridge is tightly screwed into the electrode housing, and that the inside of the housing is dry. Make sure that the +/- 5 VDC and the IN-, IN+ wires are firmly attached.

If the controller passes self test, the wiring is correct, the +/- 5 VDC signal is present and the cartridge is attached and OK, replace electrode housing.

Replace the core interface board.

Replace the sensor option board.

Disinfection Sensor Calibration Failure

This error message occurs after calibrating the chlorine or chlorine dioxide electrode. The controller will display a calibration failure if the offset calculated in the Zero Calibration is outside of the range -20 to 40 mV or the slope calculated in the One Point Process Calibration is outside of the range -10 to -100 mV per ppm.

Possible Causes

Insufficient conditioning

Insufficient sample flow

Dirty electrode.

Air bubbles on membrane

Faulty membrane.

High Pressure

No electrolyte fill solution in membrane cap

Faulty analysis equipment or reagents

Sensor cable disconnected.

Faulty core interface circuit board
(if Sensor 1).

Faulty sensor option circuit board
(if Sensors 2-4).

Corrective Actions

Wait for the appropriate amount of time before attempting a calibration.

Increase flow rate to between 30 and 100 liters per hour

Clean electrode and recalibrate as described in Section 7.6 above.

Dislodge bubbles. Adjust flow rate higher if necessary.

Replace membrane

Reduce pressure to below 1 atmosphere and refill cap with electrolyte

Fill membrane cap with electrolyte. Replace membrane cap if it will not hold solution.

Consult test equipment instructions

Reconnect cable. Make sure that the +/- 5 VDC and the IN-, IN+ wires are firmly attached.

Go to the Sensor Input Page and perform a self test. If this passes, then the problem is with the sensor or its wiring. If it fails, then disconnect the sensor from the circuit board and try the self test again. If it still fails, replace the circuit board.

Troubleshoot as above. Replace the sensor option board if self test fails.

Output Time Out

This error message indicates that the relay output has been activated for an amount of time that exceeds the user-programmed maximum allowable time. The output relay will be forced off until the “Reset Timeout” button found in that Relay Output Page is clicked.

Possible Causes

Maximum time is set too low for normal circumstances

Process value was higher/lower than normal.

Control direction is set incorrectly.

Faulty control device attached to relay.

Relay is interlocked when it should not.

Fuse blown.

Faulty wiring of control device.

Faulty relay.

You are feeding based on flow meter volume, and you are getting false contacts.

Faulty Sensor.

Chemical supply is empty.

Corrective Actions

Go to the Relay Output Page and increase the programmed value for the maximum time.

Go to the Relay Output Page and increase the programmed value for the maximum time until the process value is brought back down to normal levels.

Go to the Relay Output Page and check the setting for the control direction.

Repair or replace control device.

Evaluate switch for Interlock.

Replace fuse (F2 or F3).

Correct wiring.

Replace the relay interface board.

Go to the Flow Meter Input Page and verify that the flow total is increasing even when the solution is not flowing.

Disconnect the flow meter cable from the controller and verify that the flow total stops increasing. Route the flow meter cable away from any AC voltage and make sure that the cable is shielded.

Clean and calibrate the electrode as described in Section 7 above. If the calibration fails, see troubleshooting for sensor calibration failure.

Refill chemical supply.

Conductivity High Alarm

This error message indicates the conductivity reading exceeds the user-programmed maximum allowable value.

Possible Causes

Programmed value is too close to conductivity set point.

Control direction is set incorrectly.

Faulty control device.

Fuse blown.

Faulty control device wiring.

Faulty relay.

Corrective Actions

Go to the Conductivity Input Page and make sure that the high alarm limit is set at least 5% above the set point.

Go to the Relay Output Page and check the setting for the control direction.

Repair or replace the control device.

Replace fuse (F2 or F3).

Correct wiring.

Replace the relay interface board.

Conductivity Low Alarm

This error message indicates the conductivity reading is below the user-programmed minimum allowable value.

Possible Causes

Dirty conductivity electrode.

Faulty conductivity electrode wiring.

Faulty conductivity electrode.

Conductivity electrode is dry.

No sample flow.

Faulty control device.

Fuse blown.

Faulty control device wiring.

Faulty relay.

Intermittent Sampling, sampling too frequently

Corrective Actions

Clean and calibrate the conductivity sensor as described in Section 7.2 above. If calibration fails, see troubleshooting for Conductivity Calibration Failure above.

Correct wiring.

Replace sensor.

Adjust sensor location below the minimum water level.

Restore flow of sample

Repair or replace the control device (valve).

Replace fuse (F2 or F3).

Correct wiring.

Replace the relay interface board.

Increase the Interval Time.

pH High Alarm

This error message indicates the pH reading exceeds the user-programmed maximum allowable value.

Possible Causes

The programmed value is too close to pH set point.

Chemical supply empty.

Faulty pH electrode.

Control direction set incorrectly.

Control device set at too high a flow rate.

Metering pump is siphoning.

Faulty control device.

Blown fuse.

Faulty control device wiring.

Faulty pH output relay.

The pH dead band is set too high.

Corrective Actions

Go to the pH Input Page and make sure that the the High Alarm Limit is set at least 0.5 pH units above the set point.

Replenish chemical supply.

Clean and calibrate the electrode as described in Section 7.3 above. If the calibration fails, see troubleshooting for pH Calibration Failure above.

For acid feed the control direction should be “force lower” for caustic feed, “force higher”. Go to the Relay Output Page and verify the correct setting.

Reduce the flow rate of the control device.

Install or repair the anti-siphon valve.

Repair or replace the control device.

Replace the fuse (F2 or F3).

Correct the control device wiring.

Replace the relay interface board.

Go to the pH Output Page and change the dead band to be as low as possible to prevent the pH relay from chattering. If the pH reading fluctuates by +/- 0.02 pH units, then a dead band of 0.05 is sufficient.

pH Low Alarm

This error message indicates the pH reading is below the user-programmed minimum allowable value.

Possible Causes

The programmed value is too close to pH set point.

Chemical supply empty.

Faulty pH electrode.

Control direction set incorrectly.

Control device set at too high a flow rate.

Metering pump is siphoning.

Faulty control device.

Blown fuse.

Faulty control device wiring.

Faulty pH output relay.

The pH dead band is set too high.

Corrective Actions

Go to the pH input page and make sure that the the Low Alarm Limit is set for at least 0.5 pH units below the set point minus the dead band.

Replenish chemical supply.

Clean and calibrate the electrode as described in Section 7.3 above. If the calibration fails, see troubleshooting for pH Calibration Failure above.

For acid feed the control direction should be “force lower” for caustic feed, “force higher”. Go to the Relay Output Page and verify the correct setting.

Reduce the flow rate of the control device.

Install or repair the anti-siphon valve.

Repair or replace the control device.

Replace the fuse (F2 or F3).

Correct the control device wiring.

Replace the relay interface board.

Go to the pH Output Page and change the dead band to be as low as possible to prevent the pH relay from chattering. If the pH reading fluctuates by +/- 0.02 pH units, then a dead band of 0.05 is sufficient.

ORP High Alarm

This error message indicates the ORP reading exceeds the user-programmed maximum allowable value.

Possible Causes

The programmed value is too close to the ORP set point.

Slow ORP electrode response, dirty electrode.

Control direction set incorrectly.

Control device set at too high a flow rate.

Chemical supply empty.

Metering pump is siphoning.

If a brominator, solenoid valve is stuck open.

The ORP dead band is set too high.

Faulty control device wiring.

ORP output relay is stuck closed.

Blown fuse.

Corrective Actions

Go to the ORP Input Page and make sure that the High Alarm Limit is more than 50 mV above the set point plus the dead band.

Clean and calibrate the ORP electrode as described in Section 7.4 above. If the calibration fails, refer to the ORP Calibration Failure troubleshooting above.

For oxidizer feed the control direction should be “force higher”, for reducer “force lower”. Go to the ORP Output Page and make sure that the correct control direction is selected.

Reduce the flow rate of the control device.

Replenish chemical supply.

Repair or install an anti-siphon valve.

Repair or replace the solenoid valve.

Go to the ORP Output Page and change the dead band to be as low as possible to prevent the ORP relay from chattering. If the ORP reading fluctuates by +/- 2 mVs, then a dead band of 5 mV is sufficient.

Correct wiring.

Replace the relay board.

Replace fuse (F2 or F3).

ORP Low Alarm

This error message indicates the ORP reading is below the user-programmed maximum allowable value.

Possible Causes

The programmed value is too close to the ORP set point.

Chemical supply empty.

Faulty ORP electrode.

Control direction set incorrectly.

Faulty metering pump/brominator solenoid valve.

Metering pump is siphoning.

Blown fuse.

Faulty control device wiring.

Faulty ORP output relay.

Corrective Actions

Go to the ORP Input Page and make sure that the Low Alarm Limit is at least 50 mV below the set point.

Replenish chemical supply.

Clean and calibrate the ORP electrode as described in Section 7.4 above. If the calibration fails, refer to ORP Calibration Failure troubleshooting above.

For oxidizer feed the control direction should be “force higher”, for reducer “force lower”. Go to the ORP Output Page and make sure that the correct control direction is selected.

Repair or replace the metering pump/solenoid valve.

Repair or install an anti-siphon valve.

Replace fuse (F2 or F3).

Correct wiring.

Replace the relay board.

Drum Level Low Alarm (one for each used)

This error message appears if either a level switch or level transmitter is putting out a signal that indicates a low level of solution. This could mean that the level switch is either open or closed, or that the level transmitter is indicating a volume below the user-programmed low alarm limit.

Possible Causes

Corrective Actions

Low chemical level.

Replenish chemical supply.

Level switch float is stuck.

Clean level switch.

Faulty level switch.

Remove level switch from drum and verify that the switch opens and closes as the float is moved up and down.

Incorrect setting of the low alarm limit for the level transmitter.

Go to the Level Input Page and make sure that the Low Alarm Limit is set for the correct value.

Faulty level switch or transmitter wiring.

Correct wiring. Make sure that the level sensor is attached to the same input as the one which is defined for that drum in the Level Input Page.

Incorrect setting of “Drum low when switch is open/closed” menu.

Go to the “Level Input Page and verify that the “Drum low when switch is” menu is set for the proper selection. You can check the operation of the switch by measuring between the two wires with an ohmmeter. If there is continuity between the wires when the float is all the way down, the select “closed”.

Incorrect setting of the “Empty mA” menu.

Go to the Level Input Page and make sure that the Empty mA setting matches the actual mA of the transmitter when the tank is empty.

Faulty digital input circuit board.

If the switch is functioning, and it is wired correctly, and the settings are correct, replace the digital input board.

Faulty 4-20 mA input option circuit board.

If the level transmitter is putting out a mA signal above the low alarm limit (as measured by an ammeter) and is wired correctly, replace the 4-20 mA input option board.

Pump Failure (one for each monitored)

This error message appears if contact closures from the Feed Verification flow monitor are expected but are not detected by the digital input option circuit board.

Possible Causes

Metering pump has lost prime.
Faulty metering pump.
Faulty metering pump wiring.
Faulty Feed Verification device wiring.

Faulty Feed Verification sensor.
Blown fuse.
Faulty output relay.
Faulty digital input circuit board.

Corrective Actions

Re-prime metering pump.
Repair or replace metering pump.
Correct wiring.
Correct wiring. Make sure that digital input that the Feed Verification device is connected to has been assigned to the correct relay in the Feed Verification Page.

Replace Feed Verification sensor.
Replace fuse (F2 or F3)
Replace relay board.
Verify that Feed Verification device is making contact closures using an ohmmeter. If OK, and connected properly, replace digital input board.

4-20 mA Input High Alarm

This error message is caused by the 4-20 mA signal exceeding the user-programmed value for the high alarm limit.

Possible Causes

The process value being measured by the transmitter is out of specifications
.

The high alarm limit for the process being measured is set too low.

There is a problem with the transmitter that needs to be addressed by the manufacturer of the transmitter.

Corrective Actions

Determine the reason for the out of spec condition.

Increase the high limit in the 4-20 mA Input Page.

4-20 mA Input Low Alarm

This error message is caused by the 4-20 mA signal being lower than the user-programmed value for the low alarm limit.

Possible Causes

The process value being measured by the transmitter is out of specifications.

The low alarm limit for the process being measured is set too high.

There is a problem with the transmitter that needs to be addressed by the manufacturer of the transmitter.

Corrective Actions

Determine the reason for the out of spec condition.

Decrease the low limit in the 4-20 mA Input Page.

Conductivity Sensor Error

This error message is caused by the signal from the conductivity sensor being outside of the normal range (input voltage outside -1.45 VDC to $+1.45$ VDC or a conductivity reading above the full scale maximum). Any relay controlled by the sensor will be forced off. .

Possible Causes

The conductivity is extremely high (over full scale).

Faulty core interface or sensor option circuit board.

Faulty conductivity sensor wiring.

Faulty conductivity sensor.

Corrective Actions

Go to the Conductivity Input Page and check the uncalibrated conductivity reading. Compare this to a calibrated hand held instrument.

Go to the Conductivity Input Page and perform a self test. If this passes, then the problem is with the sensor or its wiring. If it fails, then disconnect the sensor from the circuit board and repeat the self test. If it still fails, replace the circuit board.

Make sure that the sensor cable is connected (if system conductivity) properly, and there are no shorts in any extension cables. Also make sure that the sensor cable is not routed near any AC voltage wiring. Make sure that the cable is properly shielded.

Replace sensor.

pH Sensor Error

This error message is caused by the signal from the pH electrode being outside of the normal range (pH less than -2 or greater than 16, or input voltage outside -1.45 VDC to +1.45 VDC). Any relay being controlled by the sensor will be forced off.

Possible Causes

Faulty pH cartridge.

Faulty pH electrode wiring.

Faulty preamplifier housing.

Faulty sensor input circuit board.

Corrective Actions

Replace cartridge.

Make sure that the electrode cartridge is firmly screwed into the housing. Make sure that there is no water inside the housing. Make sure that the +/- 5 VDC and the IN-, IN+ wires are firmly attached. Also make sure that the sensor cable is not routed near any AC voltage wiring. Make sure that the cable is properly shielded.

If the controller passes self test, the wiring is correct, the +/- 5 VDC signal is present and the cartridge is attached and OK, replace the housing.

Go to the pH Input Menu and perform a self test. If it fails, remove the electrode wires from the pH input board and try the self test again. If it passes, the problem is in the electrode, housing or its wiring. If it still fails, replace the pH input board.

ORP Sensor Error

This error message is caused by the signal from the ORP electrode being outside of the normal range (-1450 to 1450 mV). Any relay being controlled by the sensor will be forced off.

Possible Causes

Faulty ORP cartridge.

Faulty ORP electrode wiring.

Faulty preamplifier housing.

Faulty sensor input circuit board.

Corrective Actions

Replace cartridge.

Make sure that the electrode cartridge is firmly screwed into the housing. Make sure that there is no water inside the housing. Make sure that the +/- 5 VDC and the IN-, IN+ wires are firmly attached. Also make sure that the sensor cable is not routed near any AC voltage wiring. Make sure that the cable is properly shielded.

If the controller passes self test, the wiring is correct, the +/- 5 VDC signal is present and the cartridge is attached and OK, replace the housing.

Go to the ORP Input Menu and perform a self test. If it fails, remove the electrode wires from the ORP input board and try the self test again. If it passes, the problem is in the electrode, housing or its wiring. If it still fails, replace the ORP input board.

Temperature Sensor Error

This error message is caused by the temperature signal being outside the normal range (around 1500-33,000 ohms for contacting conductivity sensors, 15,000 to 330,000 for electrodeless conductivity sensors, 1000 to 1400 ohms for pH sensors and high temperature conductivity sensors). Any relay controlled by the faulty sensor will be forced off.

Possible Causes

Faulty temperature sensor wiring

Faulty conductivity sensor.

Faulty sensor input board

Corrective Actions

Measure the temperature signal using an ohmmeter between the green wire and the green/white wire as close to the sensor as possible, with the wires disconnected from the terminal strip. This should be around 8,000 ohms at 85 F, 30 C for a contacting electrode, 80,000 ohms for an electrodeless sensor, and 1115 ohms for a pH or high temp sensor. If OK, check this again at the terminal strip of the circuit board. If OK, make sure that the wires are connected firmly to the correct terminals.

If you measure resistance outside the acceptable range directly from the sensor, replace the sensor.

Go to the Conductivity Input Page and perform a self test. If this passes, then the problem is with the sensor or its wiring. If it fails, then disconnect the sensor from the circuit board and try the self test again. If it still fails, replace the circuit board.

Total Alarm Limit

The totalizer for a flow meter input or counter input has exceeded its programmed maximum limit.

Possible Causes

The system has experienced too high a total

You are getting false contacts.

Corrective Actions

Evaluate system

Go to the appropriate Input Page and verify that the total is increasing even when the solution is not flowing. Disconnect the input's cable from the controller and verify that the total stops increasing. Route the input's cable away from any AC voltage and make sure that the cable is shielded.

Rate High Alarm

The rate for a flow meter input or counter input has exceeded its programmed maximum limit.

Possible Causes

The system has experienced too high a rate

The rate high alarm point is too low

You are getting false contacts.

Corrective Actions

Evaluate system

Go to the input page and reset the limit

Go to the appropriate Input Page and verify that the total is increasing even when the solution is not flowing.

Disconnect the input cable from the controller and verify that the flow total stops increasing. Route the input cable away from any AC voltage and make sure that the cable is shielded.

Rate Low Alarm

The rate for a flow meter input or counter input is less than its programmed minimum limit.

Possible Causes

The system has experienced too high a rate

The rate low alarm limit is too high

The input is no longer connected

Faulty device

Faulty digital input

Corrective Actions

Evaluate system

Go to the input page and reset the alarm limit

Check the wiring. Short the cable at the device end to verify that it is OK.

Repair or replace the device.

If shorting the input does not yield a count, replace the input circuit board.

Sensor calibration time

Normal condition; programmed calibration reminder time has elapsed

4-20 mA Input Sensor Error

This error message is caused by a 4-20 mA input signal that is less than 3.9 mA or greater than 21 mA.

Possible Causes

Faulty transmitter.

Faulty wiring between transmitter and analog input option circuit board.

Faulty analog input option circuit board.

Corrective Actions

Make sure that the transmitter is functioning by measuring the output using an ammeter. If the output directly from the transmitter is less than 4 mA, the transmitter is the problem.

Repeat the measurement of the transmitter output at the 4-20 mA input option board terminal strip. If this is less than 4 mA, then the wiring is faulty. Also make sure that the wires are attached to the correct terminals as defined in the 4-20 mA Input Page.

Replace the 4-20 mA input option board.

Sensor Board Failure

This error message is caused by a failure of the controller to recognize that the option circuit board is connected. The ORP output relay will be forced off.

Possible Causes

Poor connection of the option board to the sensor interface board.

Faulty sensor input board.

Corrective Actions

Remove the option board and inspect both mating connectors for corrosion or damage. Reinstall the option board.

Replace the sensor input board.

4-20 mA Input Board Failure

This error message is caused by a failure of the controller to recognize that the option circuit board is connected. If using a 4-20 mA type water meter, then bleed/feed output will be forced off.

Possible Causes

Poor connection of the option board to the relay interface board.

Faulty 4-20 mA input board.

Corrective Actions

Remove the option board and inspect both mating connectors for corrosion or damage. Reinstall the option board.

Replace the board.

Digital Input Board Failure

This error message is caused by a failure of the controller to recognize that the option circuit board is connected. If utilizing the Interlock feature, then any outputs that are set to deactivate in case of an Interlock condition will be forced off.

Possible Causes

Poor connection of the option board to relay interface board.

Faulty digital input board.

Corrective Actions

Remove the option board and inspect both the mating connectors for corrosion or damage. Reinstall the option board.

Replace the board.

Modem Failure

This error message is caused by a failure of the controller to recognize that the option circuit board is connected.

Possible Causes

Poor connection of the option board to the core board.

Faulty modem board.

Corrective Actions

Remove the option board and inspect both mating connectors for corrosion or damage. Reinstall the option board.

Replace the board.

Ethernet Card Failure

This error message is caused by a failure of the controller to recognize that the option circuit board is connected.

Possible Causes

Poor connection of the option board to the core board.

Faulty Ethernet board.

Corrective Actions

Remove the option board and inspect both mating connectors for corrosion or damage. Reinstall the option board.

Replace the board.

Temperature High Alarm

This error message is caused by the temperature signal from the conductivity sensor exceeding the user-programmed value for the high alarm limit.

Possible Causes

The actual temperature is too high.

The programmed value is set too close to the normal operating temperature.

The temperature sensor has lost calibration.

Faulty circuit board.

Faulty temperature sensor.

Corrective Actions

Correct problem with process.

Go to the sensor input page and increase the high alarm limit.

Go to the Temperature Input Page and calibrate the temperature.

Go to the Temperature Input Page and perform a self test. If the self test fails, then the sensor input board (if makeup) or the core interface board (if system) should be replaced.

If a successful calibration is not possible, the temperature sensor is probably faulty, and the sensor should be replaced.

Temperature Low Alarm

This error message is caused by the temperature signal from a sensor being below the user-programmed value for the low alarm limit.

Possible Causes

The actual temperature is too low.

The programmed value is set too close to the normal operating temperature.

The temperature sensor has lost calibration.

Faulty circuit board.

Faulty temperature sensor.

Poor connection of temperature wires.

Corrective Actions

Correct problem with process.

Go to the sensor input page and decrease the low alarm limit.

Go to the sensor input page and calibrate the temperature.

Go to the sensor input page and perform a self test. If the self test fails, then the sensor input board (if sensors 2-4) or the core interface board (if sensor 1) should be replaced.

If a successful calibration is not possible, the temperature sensor is probably faulty, and the sensor should be replaced.

Excessive resistance from extension cables or poor connections can lower the temperature reading. Clean & tighten all connections to the temperature sensor.

8.2 PROBLEMS THAT DON'T GENERATE AN ERROR MESSAGE

Submit buttons do not appear on any page

You have logged in using a Calibration level or Read Only level password. Only the Master level password allows changes to be made.

Sensor Input menu links missing

The controller not detecting the sensor input option board at power up causes this problem.

Possible Causes

No sensor input board is installed

Loose option board connection.

Faulty sensor input board.

Corrective Actions

Install a sensor input board.

Remove power to the unit.
Push board onto pins and turn power on.

This should cause a "Sensor Board Failure" error message, but this can be cleared once the power is cycled. Replace the sensor input board.

Temperature calibration, high/low alarm menus missing from Sensor Input page

The controller not detecting the temperature sensor at power up causes this problem.

Possible Causes

The temperature sensor is not connected.

Faulty temperature sensor.

Sensor input is selected to be an ORP type

Corrective Actions

Connect the temperature sensor and turn power on.

Measure the temperature signal using an ohmmeter between the green wire and the WHT/GRN wire as close to the sensor as possible with the wires disconnected from the terminal strip. If the reading is infinite ohms, replace the sensor.

This is normal. ORP inputs do not use automatic temperature compensation.

Link to 4-20 mA Output page does not appear

The controller not detecting any 4-20 mA output boards at power up causes this problem.

Possible Causes

No 4-20 mA output boards are installed.

Poor connection of the 4-20 mA output board.

Corrective Actions

Install one or more 4-20 mA output boards and turn power on.

Remove the option board and inspect both mating connectors for corrosion or damage
Reinstall the option board on turn power on.

Link to Level page does not appear

The controller not detecting either a digital input board or an analog input board at power up causes this problem.

Possible Causes

No digital or analog input board is installed.

Poor connection of the option board.

Corrective Actions

Install the desired option board and turn power on.

Remove the option board and inspect both mating connectors for corrosion or damage
Reinstall the option board on turn power on.

Link to Digital Inputs page does not appear

The controller not detecting a digital input board at power up causes this problem.

Possible Causes

No digital input board is installed.

Poor connection of the option board.

Corrective Actions

Install the digital input option board and turn power on.

Remove the option board and inspect both mating connectors for corrosion or damage
Reinstall the option board on turn power on.

Link to Analog Inputs page does not appear

The controller not detecting an analog input board at power up causes this problem.

Possible Causes

No analog input board is installed

Poor connection of the option board

Corrective Actions

Install the analog input option board and turn power on.

Remove the option board and inspect both mating connectors for corrosion or damage
Reinstall the option board on turn power on.

Link to Software Upgrade page does not appear

This is a normal situation if your WebMasterONE has the latest revision of software installed. When a new version of software becomes available, the link will appear, you will be able to see a description of the changes, and will have the option to download it if you want.

8.3 CONNECTION PROBLEMS

“The page cannot be displayed” message on your browser

This is a standard Microsoft Internet Explorer message when a web page cannot be located.

Possible Causes

Connection has timed out.

Corrective Actions

Reconnect to WebMasterONE.

Invalid Session message instead of a page loading

Possible Causes

Session has timed out.

You’ve left the WebMasterONE pages to other Web sites and have been gone longer than 2 minutes.

Corrective Actions

Click the “log in” link, and log in again.
Increase session timeout in the Access Code page if desired.

Click the “log in” link, and log in again.

Pages load slowly

The time required for pages to load depend upon the amount of information contained in the page, the processing speed of your computer, the amount of RAM available in your computer, and the method of connecting (Ethernet, Internet, or USB connection). We recommend a minimum processor speed of 100 MHz, and minimum RAM of 40 MB.

If connecting over the Internet, then your modem speed and the amount of Internet traffic come into play as well. The WebMasterONE modem is 33K baud, so if your PC's modem is 33K baud or higher, the numbers below should be valid, given light Internet traffic.

In general, this is what you should expect:

<u>Type of Page</u>	<u>Connection Method</u>	<u>Time to Load</u>
First page loading after log in	Ethernet	30-90 seconds
System Summary, 4-20 Input, Start Up, Datalog, Comms	Ethernet	7-25 seconds
Other pages	Ethernet	3-10 seconds
First page loading after log in	USB	30-90 seconds
System Summary, 4-20 Input, Start Up, Datalog, Comms	USB	22-35 seconds
Other pages	USB	7-14 seconds
First page loading after log in	Internet	30-90 seconds
System Summary, 4-20 Input, Start Up, Datalog, Comms	Internet	13-20 seconds
Other pages	Internet	4-8 seconds

9.0 SERVICE POLICY



The WebMasterONE Series Controllers have a 2-year warranty on electronic components and a 1-year warranty on mechanical parts (keypad, terminal strip and relays). Conductivity sensors and pH/ORP electrodes have a 1-year warranty *against manufacturing defects only*.

We stock replacement parts for immediate exchange after we have isolated the cause of a problem.

Factory authorized repairs that are received via next-day-air will be returned within 24 hours. Normal turnaround time for returns is two weeks.

Out of warranty repairs are done on a flat fee basis.